



# FIRE PROTECTION AND LIFE SAFETY



**Division 10 44 00**  
**Fire Protection Cabinets**  
**Fire Extinguishers**  
**Fire Blankets**



**Division 10 43 00**  
**Defibrillators and Cabinets**  
**Emergency Oxygen Cabinets**

**Division 21 12 00**  
**Fire Suppression Hoses**  
**Hose Racks Valves and Nozzles**



**ACTIVAR** INC.

CONSTRUCTION PRODUCTS GROUP



JL INDUSTRIES



AIR LOUVERS



HIAWATHA



SAMSON



THOMAS



ACCESSORIES  
RIA  
ROOFTOP



# INTRODUCTION

## ABOUT JL INDUSTRIES

**Choices and Quality:** We offer you the convenience of the full range of products from JL Industries, Samson Products and Thomas Enterprises complete in one catalog.

Here you can find the largest selection of fire extinguisher cabinets in the industry, including steel, stainless steel, aluminum, brass and bronze with a host of optional features. JL's reputation for quality products has made us an industry standard for over 70 years.

**More Warehouse Locations:** 1-3 day shipping on hundreds of our most popular products from our centrally-located warehouses in the US with our Quick Ship Program. See a list of locations on page 24, or check the latest stock list on our website.

**Environmental:** Contact us for the documentation you need.

**Versatile Manufacturing Capabilities:** With the combined resources of our two manufacturing facilities, you can create your own distinctive cabinet with the size and features you need, for the look you want. Just Ask Us!

Our involvement with organizations such as the National Fire Prevention Association (NFPA), the Door and Hardware Institute (DHI), the Construction Specifiers Institute (CSI) and the National Association of Fire Equipment Distributors (NAFED) enables us to remain at the forefront of industry requirements with products to keep you in compliance with current building codes.

**Website Resources:** Find all of the documentation you need and the most current product information on our website at [WWW.ACTIVARCPG.COM](http://WWW.ACTIVARCPG.COM)

## WARRANTY

All fire protection products carry a one-year warranty after date of shipment against defects in materials and workmanship. We will replace or repair any product found defective within this period at our discretion. No other warranty express or implied is valid. Fire extinguishers may carry a longer warranty.

## AMERICANS WITH DISABILITIES ACT (ADA) GUIDELINES

Look for Model Numbers in Blue to find cabinets that meet the ADA 4" Projection Requirement.

- Cabinets with the number "2" as the fourth character of the model number. These models project only 4" from the wall and include a flush pull.
- All trimless and flat trim models with standard pull.
- All 1 1/4", 1 1/2", 2 1/2" or 3" trim models with standard pull—excluding bubble cabinets.



### Projection Requirements

The federal regulations for ADA Standards for Accessible Design Section: Protruding Objects Section (28 CFR 36, 4.4.1) specify that "objects projecting from walls with their leading edges between 27" and 80" (685 mm and 2030 mm) above the finished floor (AFF) shall protrude no more than 4" (100mm) into walks, halls, corridors, passageways, or aisles. Please note that a surface-mounted cabinet installed in such a way that any part of it falls between 27" and 80" AAF would not meet ADA requirements.

These are national standards which are subject to change by local authorities having jurisdiction. ADA requirements, in particular, are constantly evolving through ongoing legislative and judicial actions. For more information: <http://www.ada.gov>

### Mounting Heights

The NFPA and ADA have created guidelines for the mounting of cabinets and extinguishers to provide safety and/or easy access to the equipment. ADA guidelines specify reach ranges for building occupants who require access to equipment such as fire extinguishers and other fire safety devices. According to the ADA Standards (28 CFR 36, 4.2.5 and 4.2.6 the cabinet handle be mounted higher than 48" AFF for applications which allow for only a forward approach in a wheelchair to the object. It should be noted that these restrictions also fall within the current National Fire Protection Association (NFPA) guidelines, which call for a maximum mounting height of 60" AFF to the top of the extinguisher.

See our website for more information on mounting heights.

ADA COMPLIANT CABINET STYLES - TOP VIEW

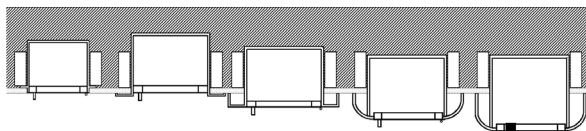

- |                                                                          |                   |                       |                           |                                                     |
|--------------------------------------------------------------------------|-------------------|-----------------------|---------------------------|-----------------------------------------------------|
| TRIMLESS<br>RECESSED<br>FLANGE FOR<br>5/8" DRYWALL<br>OR 3/4"<br>PLASTER | 3/8" FLAT<br>TRIM | 1-1/2" SQUARE<br>TRIM | 2-1/2", 3"<br>ROLLED EDGE | 4" ROLLED<br>EDGE WITH<br>RECESSED PULL<br>STANDARD |
|--------------------------------------------------------------------------|-------------------|-----------------------|---------------------------|-----------------------------------------------------|

ADA MOUNTING HEIGHTS

Recessed Pull  
w/SAF-T- LOK™

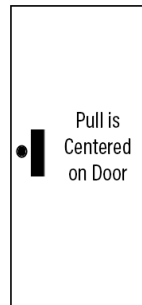

Door Styles  
w/SAF-T- LOK™

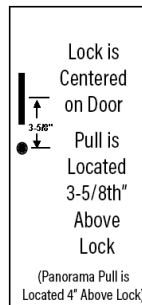

Door Styles  
w/No Lock

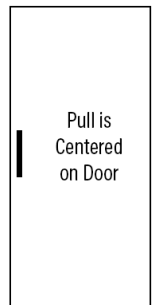



## JL INDUSTRIES FIRE-FX2™ FIRE-RATED CABINETS

- ▶ UL-Listed
- ▶ Lightweight Insulation
- ▶ Lower Shipping Costs
- ▶ Easier to Install
- ▶ Patent-Pending



1037V10FX2

JL Industries led the industry by introducing the first pre-lined Fire-Rated Cabinets in 1991. Those cabinets have changed and simplified the installation process forever.

Now, JL has taken the next step and eliminated the heavy gypsum wallboard to line cabinets, by replacing it with lightweight, mineral wool insulation. The second steel tub is not needed with the new design, reducing the weight even further.

FIRE-FX2™ cabinets are insulated with Firespan™ 90 by Thermafiber®, a UL-Listed, inorganic, mineral wool fiber insulation with a high recycled content.

**1000, 1800, 1500 Series Cabinets Weigh an average of 14.75 lbs less!**

### UL LISTED

Tested to maintain one and two-hour fire rated wall barriers, in accordance with ANSI/UL-1479 (ASTM E814 and ULC.CAN S115) for membrane penetration firestops.

### TO ORDER OR SPECIFY

Just add **FIRE-FX2™** option to the end of the seven-digit JL model number. For example, if you want an Ambassador 1017F10 with the fire rated option, ask for the **1017F10FX2**.

### FX2 WALL OPENINGS

Are slightly larger than the previous FX wall openings to accommodate FIRE-FX2™. See website for up to date catalogs and submittals.

**Look for the Red FX2 Symbol!**

### Fire-Span™ Insulation

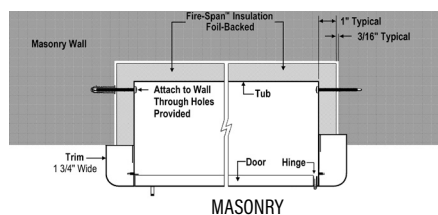
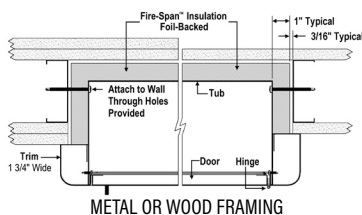

## TABLE OF CONTENTS

### STEEL

AMBASSADOR	6-7
CLASSIC	12
CLEAR VU	9
CROWNLINE VALVE/HOSE	18-19
DECORLINE	13
DEFIBRILLATOR	16
ECONOMYLINE	12
EMBASSY	10
ORBIT CABINET	14
PANORAMA	8
ROYAL BLANKET & EXTINGUISHER 3600 SERIES	20
SCHOOL	16
SECURITY	16
SMB	9

### STAINLESS STEEL

CLEAR VU	9
COSMOPOLITAN	6-7
CROWNLINE VALVE/HOSE	18-19
DEFIBRILLATOR	16
EMBASSY	10
ORBIT CABINET	14
PANORAMA	8
ROYAL BLANKET & EXTINGUISHER 3600 SERIES	20
SCHOOL	16
SECURITY	16

### ALUMINUM

ACADEMY	6-7
CLASSIC	12
CLEAR VU	9
CROWNLINE VALVE/HOSE	18-19
DECORLINE	13
DEFIBRILLATOR	16
ECONOMYLINE	12
EMBASSY	10
PANORAMA	8
ROYAL BLANKET & EXTINGUISHER 3600 SERIES	20
SM	14

### ABS PLASTIC & FIBERGLASS

ABS	12
FB	14

### BRONZE & BRASS

CAVALIER	11
CLEAR VU	9
EMBASSY	10
ORBIT CABINET	14

EXTINGUISHERS	11
AED CABINETS	16
FIRE HOSE EQUIPMENT	17
ACCESSORIES	20, 21
PROJECT GALLERY	22
KEY TO CABINET NUMBERS	23
OPTIONAL METAL FINISHES	24





# FIRE EXTINGUISHERS

## COSMIC EXTINGUISHERS: MULTI-PURPOSE CHEMICAL

**General Data:** These units contain specially fluidized and siliconized mono ammonium phosphate powder, which smothers and breaks the chain reaction on Class B fires, fuses and insulates Class A fires and is a non-conductor of electricity. Non-toxic.

**Operation:** Squeeze the lever, which opens the valve, allowing the chemical to be forced out. Upright squeeze grip operation approved to -65°F (-52°C).

**Construction:** Heavy-duty steel cylinder with rugged metal valve and siphon tube, replaceable molded valve stem seal, visual pressure gauge, pull pin and upright squeeze grip. Corrosion and impact-resistant powder coat finish.



**CLASS A,B,C Fires**

## GALAXY EXTINGUISHERS: REGULAR DRY CHEMICAL

**General Data:** These models contain a siliconized sodium bicarbonate base, the traditional dry chemical. Cleanup after use is generally easy, because the chemical does not normally bake to a hot metal surface. Non-toxic.

**Operation:** Squeeze the lever, which opens the valve, allowing the chemical to be forced out. Upright squeeze grip operation approved to -65°F (-52°C).

**Construction:** Heavy-duty steel cylinder with rugged metal valve and siphon tube with replaceable valve stem seal, visual pressure gauge pull pin and upright squeeze grip.



**CLASS B,C Fires**

## SATURN EXTINGUISHERS: CLASS A:K WET CHEMICAL

**General Data:** These units are ideal for commercial restaurant applications as a portable supplement to pre-engineered suppression systems. A low "pH" potassium acetate solution is discharged in a fine mist that provides excellent range while preventing splashing and creating an effective saponification foam-type blanket necessary for suppressing liquid cooking media fires.

**Operation:** Squeeze the lever, which opens the valve, allowing the chemical to be forced out.

**Construction:** Stainless steel cylinder with protective nozzle tip orifice seal and non-metallic nozzle tip finger guard. Industry standard horn and nozzle design. Name plate shows only the class "K" symbol.



**CLASS A: K Fires.**

All units meet the current requirements established by the National Fire Protection Association (NFPA) for NFPA10 (2013 version) "Standard for Portable Fire Extinguishers", and any other applicable NFPA standards. All units UL listed for US and Canada and meet local and national OSHA requirements for fire extinguishers.



**CLASS A FIRES - PAPER, WOOD, CLOTH, ETC., WHERE QUENCHING BY WATER OR INSULATING BY DRY CHEMICAL IS EFFECTIVE.**



**CLASS B FIRES - FLAMMABLE LIQUIDS WHERE SMOTHERING ACTION IS REQUIRED.**



**CLASS C FIRES - LIVE ELECTRICAL EQUIPMENT WHERE THE NON-CONDUCTIVITY OF EXTINGUISHANT IS VITAL.**



**CLASS K FIRES**

## MERCURY EXTINGUISHERS: HALOTRON®

**General Data:** This model contains the clean extinguishing agent Halotron® 1, which is EPA-approved, government-accepted and specified. This agent discharges as a liquid, then quickly evaporates, leaving no residue to clean up afterwards. U.S. FAA-approved for use in airports. Electrically non-conductive.

**Operation:** Squeeze the lever, which opens the valve, allowing the chemical to be forced out.

Temperature range from -40°F to +120°F.

**Construction:** Drawn steel cylinder with steel siphon tubes, power cone discharge stream, upright squeeze grip visual pressure gauge and corrosion-resistant paint finish.

**CLASS A,B,C Fires**



## SENTINEL EXTINGUISHERS: CARBON DIOXIDE

**General Data:** This extinguisher contains liquid carbon dioxide under pressure.

**Operation:** Squeeze the lever, which opens the valve, allowing the carbon dioxide to be forced out. The discharge, which changes into a gas and appears as a smothering cloud of white snow, is then directed to the fire through a funnel-shaped horn. Electrically non-conductive.

**Construction:** Lightweight, high-pressure, aluminum cylinder with O-ring seal and straight thread all-metal valve fits all sizes. The Sentinel is absolutely rust-free and up to 30% lighter than CO2 units with steel cylinders.

**CLASS B,C Fires**



## NEBULA EXTINGUISHERS: WATER MIST FOR ELECTRICAL

**General Data:** This non-toxic water mist extinguisher is ideal for Class A fires and where a potential Class C (electrical) hazard exists. Units shipped empty.

**Operation:** The unique misting nozzle provides safety from electrical shock, making this extinguisher ideal for use in telecommunications and cleanroom environments.

**Construction:** Non-magnetic cylinder and misting nozzle. For use in medical facilities.

**CLASS A,C Fires**



## GRENADIER EXTINGUISHERS: PRESSURIZED WATER

**General Data:** The "water press" extinguisher contains water and compressed air. Units shipped empty.

**Operation:** Squeeze the lever, which opens the valve, allowing the water to be forced out. Upright squeeze grip operation.

**Construction:** Butt-welded 304-L stainless steel cylinder (eliminates all internal and external crevices). Rugged stainless steel discharge lever and fixed carry handle with visual pressure gauge, pull pin. Heavy-duty, brass, chrome-plated valve body with replaceable molded valve stem seal. UL labeled chemical engine hose.

**CLASS A Fires**





## WHEELED EXTINGUISHERS: MULTI-PURPOSE AND REGULAR DRY CHEMICAL

**General Data:** Available in three size capacities with two choices of extinguishing agent and three different operational design configurations, the best match for your hazard protection needs can be accurately selected, maximizing the fire safety of your operation. Easily transportable through doorways and over rough terrain. See submittals for complete information.

**Typical Uses:** Offshore rigs, ship docks, refineries, chemical plants, aircraft ramps, processing plants, storage and loading areas.

**Construction:** DOT approved cylinders with chrome plated brass valve assemblies. Cylinders are manufactured to DOT specification 4BW240. Highly visible pressure-indicating gauge. Cylinders and carriages are shot blasted, primed and coated with powder paint finish that exceeds Underwriter's Laboratories 240 hour salt spray requirements. Hoses are included see submittal for sizes. All units are equipped with all weather semi-pneumatic 12.3 inch diameter, 3.5 inch wide tires that allows for easy movability through narrow doors and walkways by a single operator. Built to ANSI/UL 299 and 711 standards.

**Other Extinguishant Types:** Carbon Dioxide and Halotron™ wheeled units also available. See website for more information.



## LOW PROFILE ORBIT EXTINGUISHERS: MULTI-PURPOSE ABC OR PURPLE K

**General Data:** Available for wall in both Multi-Purpose ABC or Purple K (FE10VB & FPK10VB) or available in cabinet mount version with Multi-Purpose ABC (FE10V). See JL's low profile 2100 series cabinet on pg. 14.

**Operation:** Squeeze the lever, which opens the valve, allowing the chemical to be forced out. Temperature range from -40°F to +120°F.

**Construction:** Corrosion-resistant, powder coated, tempered aluminum vessel with aluminum valve and siphon tube. Visual pressure gauge, stainless steel pull pin, handles, bracket and button hook.



Model	Nominal Capacity	Shipping Weight	Cylinder Diameter	Overall Height	Overall Width	Shipping Volume	U/L Rating	Optional Mounting Bracket	US Coast Guard Approved
Grenadier-P	2-1/2 gal.	7.75 lbs.	7	24-1/2	9	1.1 cu.ft.	2A	MB810	YES
Cosmic 2-1/2E*	2-1/2 lbs.	5.5 lbs.	3-3/8	15-1/2	5-3/4	.2 cu.ft.	1A-10B:C	MB817C or MB817A*	YES
Cosmic 5E	5 lbs.	10 lbs.	4-1/4	16-3/8	7-1/4	.35 cu.ft.	3A-40B:C	MB818C or MB 818A	YES
Cosmic 6E	6 lbs.	12.75 lbs.	5	16	7-3/4	.5 cu.ft.	3A-40B:C	MB808A	YES
Cosmic 10E	10 lbs.	18.25 lbs.	5-1/8	21	7-3/4	.65 cu.ft.	4A-80B:C	MB846C or MB846A	YES
Cosmic 20E (FE20C)	20 lbs.	33.5 lbs.	7-1/2	21-1/4	8-3/4	1.0 cu.ft.	10A-120B:C	MB811C	YES
Cosmic 20E (FE20A)	20 lbs.	38 lbs.	7	24	10-1/4	1.0 cu.ft.	10A-120B:C	MB810A	YES
Sentinel 5	5 lbs.	14 lbs.	5-1/4	17-3/4	8-1/4	.65 cu.ft.	5B:C	MB809C or MB809A	YES
Sentinel 10	10 lbs.	28.25 lbs.	7	24	12	1.3 cu.ft.	10B:C	MB810C or MB810A	YES
Sentinel 15	15 lbs.	37.75 lbs.	7	30	12	1.0 cu.ft.	10B:C	MB810C or MB864A	YES
Sentinel 20	20 lbs.	50.75 lbs.	8	30	13	2.1 cu.ft.	10B:C	MB811C or MB811A	YES
Galaxy 2-1/2*	2-1/2 lbs.	5.5 lbs.	3-3/8	15-1/2	5-3/4	.2 cu.ft.	10B:C	MB817C or MB817A*	YES
Galaxy 5	5 lbs.	9.25 lbs.	4-1/4	15-1/4	5-1/2	.35 cu.ft.	10B:C	MB818A	YES
Galaxy 5-1/2	5-1/2 lbs.	10.5 lbs.	4-1/4	16-3/8	7-1/4	.4 cu.ft.	40B:C	MB818C or MB818A	YES
Galaxy 6	6 lbs.	13.75 lbs.	5	16-1/4	8-1/2	.5 cu.ft.	40B:C	MB808A	YES
Galaxy 10	10 lbs.	18.25 lbs.	5-1/8	21	7-3/4	.65 cu.ft.	40B:C or 60B:C	MB846C or MB846A	YES
Galaxy 20	20 lbs.	38 lbs.	7-1/2	23-1/4	10-1/4	1.0 cu.ft.	120B:C	MB810C or MB810A	YES
Mercury 2-1/2*	2-1/2 lbs	5.25 lbs	3-3/8	15-1/2	6-3/8	.25 cu.ft.	2B:C	MB817C or MB817A*	N/A
Mercury 5	5 lbs	9.5 lbs	4-1/4	16-3/8	7-1/4	.3 cu.ft.	5B:C	MB818C or MB818A	YES
Mercury 11 (FM11C)	11 lbs	21.25 lbs	7	17-1/2	8-5/8	1.0 cu.ft.	1A-10B:C	MB810C	YES
Mercury 11 (FM11A)	11 lbs	22.5 lbs	6	21-7/8	9-1/4	1.0 cu.ft.	1A-10B:C	MB812A	YES
Mercury 15-1/2 (FM15C)	15-1/2 lbs	25.75 lbs	7	17-1/2	8-5/8	1.0 cu.ft.	2A-10B:C	MB810C	YES
Mercury 15-1/2 (FM15A)	15-1/2 lbs	27.5 lbs	6	21-7/8	9-1/4	1.0 cu.ft.	2A-10B:C	MB812A	YES
Saturn 15	1.8 gal	22.5 lbs	7	19-1/4	9	.9 cu.ft.	1-A:K or 2-A:K	MB810C or MB810A	--
Saturn 25	2.5 gal	33.5 lbs.	7	24-1/2	9	1.1 cu.ft.	1-A:K or 2-A:K	MB810C or MB810A	--
Nebula 270	1.75 gal	7 lbs. «	7	24-1/2	11	1.1 cu. ft.	2A:C	MB810NM	--
Nebula 272	2.5 gal	8 lbs. «	7	27-1/2	11	1.3 cu ft.	2A:C	MB810NM	--
Nebula 250	2.5 gal	8.3 lbs.«	7	28	14	1.3 cu ft.	2A:C	--	--
Orbit ABC 10 (FE10V)	10 lbs.	28.5 lbs.	3 x 10	22	11		4A:80B:C	Button Hook Incl. for Wall or Cabinet Mount	--
Orbit ABC 10 (FE10VB)	10 lbs.	26.5 lbs.	3 -1/2 x 8	23	9		4A:80B:C	Wall Mount Button Hook Incl.	--
Orbit Purple K 10 (FPK10VB)	10 lbs.	26.6 lbs.	3.5 x 8	23	9		80-B:C	Wall Mount Button Hook Incl.	--

Dimensions in Inches

\*INDICATES MOUNTING BRACKET STANDARD. J HOOK WALL BRACKET STANDARD WITH ALL OTHER EXTINGUISHERS.

NOTE: JL EXTINGUISHERS ARE SHIPPED FULLY CHARGED WITH THE EXCEPTION OF THE GRENADE & NEBULA. NFPA REGULATIONS ALSO REQUIRE EXTINGUISHERS TO BE INSPECTED WHEN INITIALLY PLACED IN SERVICE AND ALL LOCAL FIRE CODE AND ALL LOCAL FIRE CODE AND TAGGING REQUIREMENTS MUST BE ADHERED TO. ALL FIRE EXTINGUISHER SIZES ARE NOMINAL. CONTACT CUSTOMER SERVICE FOR MORE INFORMATION ABOUT ORDERING TAGGED EXTINGUISHERS IN YOUR AREA.



# FIRE EXTINGUISHER CABINETS

## AMBASSADOR SERIES: STEEL TRIM AND DOOR

**Door and Trim Construction:** Cold rolled steel with white powder-coat finish standard. Flush cabinet doors with a 5/8" door stop are attached by a continuous hinge and equipped with zinc-plated handle and roller catch.

**Trim Style and Depth:** Trimless Recessed - for 5/8" depth drywall or 3/4" plaster. Recessed - 3/8" flat trim. Semi-Recessed - 1 1/4", 1 1/2" Square Edge or 2 1/2", 3", 4" (recessed pull), 4 1/2" Rolled Edge. Surface-mount has a square edge or optional rolled edge upon request. 1 3/4" face trim on frame and 1 1/4" trim on doors with glazing.

**Tub:** Constructed of cold rolled steel with white powder-coat finish standard.

**Options at Additional Cost:** Color door and trim or tub. Rolled Edge Surface Mount Cabinet. Custom colors. See page 24.

**Fire-Rated Option Available:** Yes



AMBASSADOR 1017F10  
WITH OPTIONAL LETTERING  
(BLK OPTION)



AMBASSADOR  
1013F10

## ACADEMY SERIES: ALUMINUM TRIM AND DOOR

**Door and Trim Construction:** Clear anodized aluminum. Flush cabinet doors with a 5/8" door stop are attached by a continuous hinge and equipped with zinc-plated handle and roller catch.

**Trim Style and Depth:** Trimless Recessed - for 5/8" depth drywall or 3/4" plaster. Recessed - 3/8" flat trim. Semi-Recessed - 1 1/4", 1 1/2" Square Edge or 2 1/2", 3", 4" (recessed pull), 4 1/2" Rolled Edge. Surface-mount has a square edge. 1 3/4" face trim on frame and 1 1/4" trim on doors with glazing. Rolled edge models are constructed of mechanically-joined extrusions, except for models 1827 and 1027 which are die formed. Die formed corners provide an attractive, rounded edge - unique to the JL line of cabinets!

**Tub:** Constructed of cold rolled steel with white powder-coat finish standard. Surface-mounted models have clear anodized aluminum tubs.

**Options at Additional Cost:** Dark bronze anodized finish. See page 24. Aluminum tub for non-rated use (#180 clear anodized).

**Fire-Rated Option Available:** Yes



ACADEMY 1027V10 (DK  
BRONZE OPTION )



ACADEMY C1027V10

## COSMOPOLITAN SERIES: STAINLESS STEEL TRIM AND DOOR

**Door and Trim Construction:** No. 4 Stainless Steel Trim and Door. Flush cabinet doors with a 5/8" door stop are attached by a continuous hinge and equipped with zinc-plated handle and roller catch.

**Trim Style and Depth:** Trimless Recessed - for 5/8" depth drywall or 3/4" plaster. Recessed - 3/8" flat trim. Semi-Recessed - 1 1/4", 1 1/2" Square Edge or 2 1/2", 3", 4" (recessed pull), 4 1/2" Rolled Edge. Surface-mount has a square edge or optional rolled edge upon request. 1 3/4" face trim on frame and 1 1/4" trim on doors with glazing.

**Tub:** Constructed of cold rolled steel with white powder-coat finish standard. Surface-mounted models have No 4 stainless tubs.

**Options at Additional Cost:** Custom stainless finishes - #6 satin, #7 polished, #8 mirror. Stainless tub with #4 finish. Rolled Edge Surface Mount Cabinet.

**Fire-Rated Option Available:** Yes



COSMOPOLITAN 1036F16  
(POLISHED #7)



COSMOPOLITAN  
1035S21

## CABINET OPTIONS FOR ALL MODELS: AMBASSADOR, ACADEMY & COSMOPOLITAN

### Door Styles w/Pull

- F** Full Glazing
- G** Full Glazing & SAF-T-LOK™
- D** Horizontal Duo Panel
- E** Horizontal Duo Panel & SAF-T-LOK™
- S21** Solid
- L22** Solid & SAF-T-LOK™
- L24** Solid with Cylinder Lock & No Handle
- B10** Solid with 2" x 4" Acrylic Insert & SAF-T-LOK
- V** Vertical Duo
- W** Vertical Duo & SAF-T-LOK™

### Door Glazing

- 10** Clear Acrylic
- 13** Clear Wire Glass w/ Safety Film
- 15** Bronze Acrylic
- 16** Gray Acrylic
- 17** Clear Tempered Glass
- 18** Laminated Safety Glass

### Options at Additional Cost

- Vertical or Horizontal Lettering - See Page 21
- Futura Embossed "Fire" Handle in Mill, White or Red
- Flush Pull or Chrome Pull
- Wall Signs & Alarms - See Page 20
- Red or Black Painted Steel Tub
- Engraved Metal Door or Etched Glass

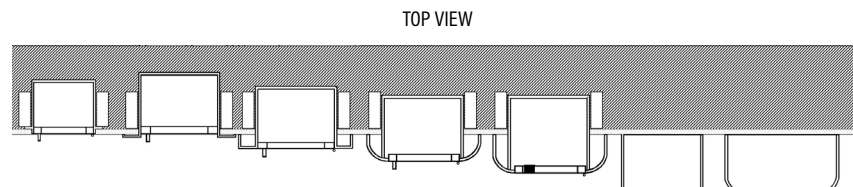

- TRIMLESS RECESSED FLANGE FOR 5/8" DRYWALL OR 3/4" PLASTER
- 3/8" FLAT TRIM
- 1-1/2" SQUARE TRIM
- 2-1/2", 3" ROLLED EDGE
- 4" ROLLED EDGE WITH RECESSED PULL STANDARD
- SURFACE MOUNT SQUARE TRIM
- SURFACE MOUNT OPTIONAL ROLLED EDGE



# FIRE EXTINGUISHER CABINETS



## AMBASSADOR, ACADEMY, COSMOPOLITAN: DOOR STYLES

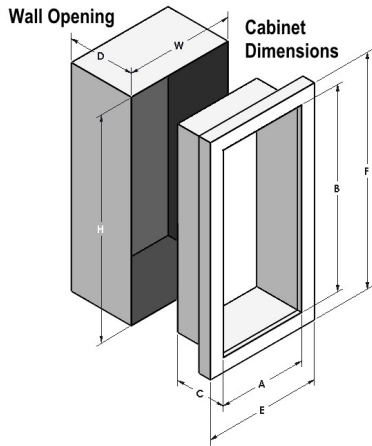

### SELECTION CHART FOR AMBASSADOR, ACADEMY, COSMOPOLITAN SERIES

Trim and Door Material and Series #			Trim Style	Tub I.D.			Frame O.D.		Wall Opening: Non-rated			Wall Opening: FX2 Option			Accommodates Following Extinguishers
Steel	Aluminum	Stainless Steel		A	B	C	E	F	W	H	D	W	H	D	
AMBASSADOR	ACADEMY	COSMOPOLITAN		Width	Height	Depth									
8114	8124	8134	Trimless 5/8" Drywall ‡	9	18	5 1/2	12 1/8	21 1/8	10	19	5 5/8	11 5/16	20 5/16	6 3/16	Cosmic & Galaxy 2.5-6, Mercury 2.5-5 (Mount 6lb to tub)
8115	8125	8135	Flat Trim	9	18	5 1/2	12 3/8	21 3/8	10	19	5 3/8	11 5/16	20 5/16	6 7/16	
8116	8126	8136	1 1/2" Square	9	18	5 1/2	12 3/8	21 3/8	10	19	4 1/8	11 5/16	20 5/16	5 3/16	
8117	8127	8137	2 1/2" Rolled	9	18	5 1/2	12 3/8	21 3/8	10	19	3 1/8*	11 5/16	20 5/16	4*	
8113	8123	8133	Surf. Mtd.	12 3/16	21 3/16	6	12 3/8	21 3/8	--	--	--	--	--	--	
1710	1720	1730	2 1/4" Square	10 1/2	24	5	13 7/8	27 3/8	11 1/2	25	3	12 13/16	26 5/16	4	Cosmic & Galaxy 2.5-6, Mercury 2.5 & 5 (Mount 6lb to tub)
1815	1825	1835	Flat Trim	10 1/2	24	5 1/2	13 7/8	27 3/8	11 1/2	25	5 3/8	12 13/16	26 5/16	6 7/16	
1816	1826	1836	1 1/2" Square	10 1/2	24	5 1/2	13 7/8	27 3/8	11 1/2	25	4 1/8	12 13/16	26 5/16	5 3/16	
1817	1827	1837	3" Rolled	10 1/2	24	5 1/2	13 7/8	27 3/8	11 1/2	25	2 5/8	12 13/16	26 5/16	3 5/8	
1812	1822	1832	4" Rolled, Flush Pull	10 1/2	24	5 1/2	13 7/8	27 3/8	11 1/2	25	1 7/8*	12 13/16	26 5/16	2 7/8*	
1818	1828	1838	4 1/2" Rolled	10 1/2	24	5 1/2	13 7/8	27 3/8	11 1/2	25	1 1/8*	12 13/16	26 5/16	2 3/16*	
1014	1024	1034	Trimless 5/8" Drywall ‡	10 1/2	24	6	13 5/8	27 1/8	11 1/2	25	6 1/8	12 13/16	26 5/16	6 11/16	Cosmic & Galaxy 2.5-10, Mercury 2.5 & 5, Sentinel 5
1015	1025	1035	Flat Trim	10 1/2	24	6	13 7/8	27 3/8	11 1/2	25	5 7/8	12 13/16	26 5/16	6 15/16	
1016	1026	1036	1 1/2" Square	10 1/2	24	6	13 7/8	27 3/8	11 1/2	25	4 5/8	12 13/16	26 5/16	5 11/16	
1017	1027	1037	3" Rolled	10 1/2	24	6	13 7/8	27 3/8	11 1/2	25	3 1/8	12 13/16	26 5/16	4	
1012	1022	1032	4" Rolled, Flush Pull	10 1/2	24	6	13 7/8	27 3/8	11 1/2	25	2 3/8*	12 13/16	26 5/16	3 3/8*	
1018	1028	1038	4 1/2" Rolled	10 1/2	24	6	13 7/8	27 3/8	11 1/2	25	1 5/8*	12 13/16	26 5/16	2 11/16*	
1013	1023	1033	Surf. Mtd.	13 11/16	27 3/16	6 1/2	13 7/8	27 3/8	--	--	--	--	--	--	
2014	2024	2034	Trimless 5/8" Drywall ‡	12	27	7 3/4	15 1/8	30 1/8	13	28	7 7/8	14 5/16	29 5/16	8 7/16	Any Cosmic**, Galaxy**, Mercury, Saturn or Grenadier P, Sentinel 5 & 10
2015	2025	2035	Flat Trim	12	27	7 3/4	15 3/8	30 3/8	13	28	7 5/8	14 5/16	29 5/16	8 11/16	
2016	2026	2036	1 1/4" Square	12	27	7 3/4	15 3/8	30 3/8	13	28	6 5/8	14 5/16	29 5/16	7 11/16	
2017	2027	2037	2 1/2" Rolled	12	27	7 3/4	15 3/8	30 3/8	13	28	5 3/8*	14 5/16	29 5/16	6 7/16*	
2012	2022	2032	4" Rolled, Flush Pull	12	27	7 3/4	15 3/8	30 3/8	13	28	4 1/8*	14 5/16	29 5/16	5 1/8*	
2018	2028	2038	4 1/2" Rolled	12	27	7 3/4	15 3/8	30 3/8	13	28	3 3/8*	14 5/16	29 5/16	4 7/16*	
2013	2023	2033	Surf. Mtd.	15 3/16	30 3/16	8 1/4	15 3/8	30 3/8	--	--	--	--	--	--	
3015	3025	3035	Flat Trim	16	32	7 3/4	19 3/8	35 3/8	17	33	7 5/8	18 5/16	34 5/16	8 11/16	Any Cosmic**, Galaxy**, Mercury, Saturn or Grenadier P, Sentinel 5 & 10 & 15, 272
3016	3026	3036	1 1/4" Square	16	32	7 3/4	19 3/8	35 3/8	17	33	6 5/8	18 5/16	34 5/16	7 11/16	
3017	3027	3037	2 1/2" Rolled	16	32	7 3/4	19 3/8	35 3/8	17	33	5 3/8*	18 5/16	34 5/16	6 7/16*	
3012	3022	3032	4" Rolled, Flush Pull	16	32	7 3/4	19 3/8	35 3/8	17	33	4 1/8*	18 5/16	34 5/16	5 1/8*	
3018	3028	3038	4 1/2" Rolled	16	32	7 3/4	19 3/8	35 3/8	17	33	3 3/8*	18 5/16	34 5/16	4 7/16*	
3013	3023	3033	Surf. Mtd.	19 3/16	35 3/16	8 1/4	19 3/8	35 3/8	--	--	--	--	--	--	
4015	4025	4035	Flat Trim	20	27	7 3/4	23 3/8	30 3/8	21	28	7 5/8	22 5/16	29 5/16	8 11/16	Two Each of Any Cosmic**, Galaxy**, Mercury, Saturn or Grenadier P, Sentinel 5
4016	4026	4036	1 1/4" Square	20	27	7 3/4	23 3/8	30 3/8	21	28	6 5/8	22 5/16	29 5/16	7 11/16	
4017	4027	4037	2 1/2" Rolled	20	27	7 3/4	23 3/8	30 3/8	21	28	5 3/8*	22 5/16	29 5/16	6 7/16*	
4012	4022	4032	4" Rolled, Flush Pull	20	27	7 3/4	23 3/8	30 3/8	21	28	4 1/8*	22 5/16	29 5/16	5 1/8*	
4018	4028	4038	4 1/2" Rolled	20	27	7 3/4	23 3/8	30 3/8	21	28	3 3/8*	22 5/16	29 5/16	4 7/16*	
4013	4023	4033	Surf. Mtd.	23 3/16	30 3/16	8 1/4	23 3/8	30 3/8	--	--	--	--	--	--	

Dimensions in Inches

‡ TRIMLESS MODELS FEATURE NEW DESIGN AND MAY BE INSTALLED BEFORE DRYWALL - SEE SUBMITTAL AND INSTALLATION INFORMATION

\*ADD 5/8" WALL DEPTH FOR CABINETS WITH ALUMINUM FRAMES.

\*\*COSMIC 20 & GALAXY 20 EXTINGUISHER MUST BE MOUNTED ON THE BACK OF THE CABINET TUB.



# FIRE EXTINGUISHER CABINETS

## PANORAMA SERIES: FRAMELESS ACRYLIC DOOR

**Door and Trim Construction:** The Panorama features a frameless acrylic door of clear or opaque textured acrylic. The "stippled" texture of the opaque doors and exclusive aluminum backing protect the lettering, which is available in 3 colors and configurations. Clear doors also available. Flush cabinet doors are attached by a continuous hinge and equipped with zinc-plated handle and roller catch. Trim is cold rolled steel with white powder-coat, clear anodized aluminum, or #4 stainless steel. 4" Rolled trim cabinets with P and Q style door have recessed pull to meet ADA projection standards.

**Trim Style and Depth:** Trimless Recessed - for 5/8" depth drywall or 3/4" plaster. Recessed - 3/8" flat trim. Semi-Recessed - 1 1/4", 1 1/2" Square Edge or 2 1/2", 3", 4" (recessed pull), 4 1/2" Rolled Edge. Surface-mount has a square edge or optional rolled edge for steel or stainless steel upon request. 1 3/4" face trim on frame. See page 6.

**Tub:** Constructed of cold rolled steel with white powder-coat finish standard.

**Fire-Rated Option Available:** Yes

### Door Styles w/Pull

**C70** Clear 3/16" Unlettered Smooth Acrylic

**C71** Clear 3/16" Unlettered Smooth Acrylic with SAF-T-LOK™

**P** Identity: 3/16" Textured Obscure Acrylic with Lettering

**Q** Identity: 3/16" Textured Obscure Acrylic with Lettering & SAF-T-LOK™

### Options at Additional Cost

Futura Pull,

Flush Pull for P and Q Style Doors

Other Color Tub

Wall Signs & Alarms - Page 21

### Door Glazing

**40** Vertical Black Bkgd, White Lettering

**41** Vertical Red Bkgd, White Lettering

**42** Vertical White Bkgd, Black Lettering

**43** Vertical White Bkgd, Red Lettering

**45** Horizontal Black Bkgd, White Lettering

**46** Horizontal Red Bkgd, White Lettering

**47** Horizontal White Bkgd, Black Lettering

**48** Horizontal White Bkgd, Red Lettering

**50** Ascending, Black Bkgd, White Lettering

**51** Ascending, Red Bkgd, White Lettering

**52** Ascending, White Bkgd, Black Lettering

**53** Ascending, White Bkgd, Red Lettering



PANORAMA  
1036C70 W/  
COSMIC 10E



PANORAMA  
1012P48 FLUSH  
PULL STANDARD



### SELECTION CHART FOR PANORAMA SERIES

Trim and Door Material and Series #				Tub I.D.			Frame O.D.		Wall Opening: Non-rated			Wall Opening: FX2 Option			Accommodates Following Extinguishers
Steel	Alumi- num	Stainless Steel	Trim Style	A	B	C	E	F	W	H	D	W	H	D	
8114	--	--	Trimless 5/8" Drywall ‡	9	18	5 1/2	12 1/8	21 1/8	10	19	5 5/8	11 5/16	20 5/16	6 3/16	Cosmic & Galaxy 2.5-6, Mercury 2.5-5 (Mount 6lb to tub)
8115	8125	8135	Flat Trim	9	18	5 1/2	12 3/8	21 3/8	10	19	5 3/8	11 5/16	20 5/16	6 7/16	
8116	8126	8136	1 1/2" Square	9	18	5 1/2	12 3/8	21 3/8	10	19	4 1/8	11 5/16	20 5/16	5 3/16	
8117	8127	8137	2 1/2" Rolled	9	18	5 1/2	12 3/8	21 3/8	10	19	3 1/8*	11 5/16	20 5/16	4*	
8113	8123	8133	Surf. Mtd.	12 3/16	21 3/16	6	12 3/8	21 3/8	--	--	--	--	--	--	
1815	1825	1835	Flat Trim	10 1/2	24	5 1/2	13 7/8	27 3/8	11 1/2	25	5 3/8	12 13/16	26 5/16	6 7/16	Cosmic & Galaxy 2.5-6, Mercury 2.5 & 5 (Mount 6lb to tub)
1816	1826	1836	1 1/2" Square	10 1/2	24	5 1/2	13 7/8	27 3/8	11 1/2	25	4 1/8	12 13/16	26 5/16	5 3/16	
1817	1827	1837	3" Rolled	10 1/2	24	5 1/2	13 7/8	27 3/8	11 1/2	25	2 5/8	12 13/16	26 5/16	3 5/8	
1812	1822	1832	4" Rolled, Flush Pull	10 1/2	24	5 1/2	13 7/8	27 3/8	11 1/2	25	1 7/8*	12 13/16	26 5/16	2 7/8*	
1818	1828	1838	4 1/2" Rolled	10 1/2	24	5 1/2	13 7/8	27 3/8	11 1/2	25	1 1/8*	12 13/16	26 5/16	2 3/16*	
1014	--	--	Trimless 5/8" Drywall ‡	10 1/2	24	6	13 5/8	27 1/8	11 1/2	25	6 1/8	12 13/16	26 5/16	6 11/16	Cosmic & Galaxy 2.5-10, Mercury 2.5 & 5, Sentinel 5
1015	1025	1035	Flat Trim	10 1/2	24	6	13 7/8	27 3/8	11 1/2	25	5 7/8	12 13/16	26 5/16	6 15/16	
1016	1026	1036	1 1/2" Square	10 1/2	24	6	13 7/8	27 3/8	11 1/2	25	4 5/8	12 13/16	26 5/16	5 11/16	
1017	1027	1037	3" Rolled	10 1/2	24	6	13 7/8	27 3/8	11 1/2	25	3 1/8	12 13/16	26 5/16	4	
1012	1022	1032	4" Rolled, Flush Pull	10 1/2	24	6	13 7/8	27 3/8	11 1/2	25	2 3/8*	12 13/16	26 5/16	3 3/8*	
1018	1028	1038	4 1/2" Rolled	10 1/2	24	6	13 7/8	27 3/8	11 1/2	25	1 5/8*	12 13/16	26 5/16	2 11/16*	
1013	1023	1033	Surf. Mtd.	13 11/16	27 3/16	6 1/2	13 7/8	27 3/8	--	--	--	--	--	--	
2014	--	--	Trimless 5/8" Drywall ‡	12	27	7 3/4	15 1/8	30 1/8	13	28	7 7/8	14 5/16	29 5/16	8 7/16	Any Cosmic**, Galaxy**, Mercury, Saturn or Grenadier P, Sentinel 5 & 10
2015	2025	2035	Flat Trim	12	27	7 3/4	15 3/8	30 3/8	13	28	7 5/8	14 5/16	29 5/16	8 11/16	
2016	2026	2036	1 1/4" Square	12	27	7 3/4	15 3/8	30 3/8	13	28	6 5/8	14 5/16	29 5/16	7 11/16	
2017	2027	2037	2 1/2" Rolled	12	27	7 3/4	15 3/8	30 3/8	13	28	5 3/8*	14 5/16	29 5/16	6 7/16*	
2012	2022	2032	4" Rolled, Flush Pull	12	27	7 3/4	15 3/8	30 3/8	13	28	4 1/8*	14 5/16	29 5/16	5 1/8*	
2018	2028	2038	4 1/2" Rolled	12	27	7 3/4	15 3/8	30 3/8	13	28	3 3/8*	14 5/16	29 5/16	4 7/16*	
2013	2023	2033	Surf. Mtd.	15 3/16	30 3/16	8 1/4	15 3/8	30 3/8	--	--	--	--	--	--	
3015	3025	3035	Flat Trim	16	32	7 3/4	19 3/8	35 3/8	17	33	7 5/8	18 5/16	34 5/16	8 11/16	
3016	3026	3036	1 1/4" Square	16	32	7 3/4	19 3/8	35 3/8	17	33	6 5/8	18 5/16	34 5/16	7 11/16	
3017	3027	3037	2 1/2" Rolled	16	32	7 3/4	19 3/8	35 3/8	17	33	5 3/8*	18 5/16	34 5/16	6 7/16*	
3012	3022	3032	4" Rolled, Flush Pull	16	32	7 3/4	19 3/8	35 3/8	17	33	4 1/8*	18 5/16	34 5/16	5 1/8*	
3018	3028	3038	4 1/2" Rolled	16	32	7 3/4	19 3/8	35 3/8	17	33	3 3/8*	18 5/16	34 5/16	4 7/16*	
3013	3023	3033	Surf. Mtd.	19 3/16	35 3/16	8 1/4	19 3/8	35 3/8	--	--	--	--	--	--	
4015	4025	4035	Flat Trim	20	27	7 3/4	23 3/8	30 3/8	21	28	7 5/8	22 5/16	29 5/16	8 11/16	Two Each of Any Cosmic**, Galaxy**, Mercury, Saturn or Grenadier P, Sentinel 5
4016	4026	4036	1 1/4" Square	20	27	7 3/4	23 3/8	30 3/8	21	28	6 5/8	22 5/16	29 5/16	7 11/16	
4017	4027	4037	2 1/2" Rolled	20	27	7 3/4	23 3/8	30 3/8	21	28	5 3/8*	22 5/16	29 5/16	6 7/16*	
4012	4022	4032	4" Rolled, Flush Pull	20	27	7 3/4	23 3/8	30 3/8	21	28	4 1/8*	22 5/16	29 5/16	5 1/8*	
4018	4028	4038	4 1/2" Rolled	20	27	7 3/4	23 3/8	30 3/8	21	28	3 3/8*	22 5/16	29 5/16	4 7/16*	
4013	4023	4033	Surf. Mtd.	23 3/16	30 3/16	8 1/4	23 3/8	30 3/8	--	--	--	--	--	--	

Dimensions in Inches

‡ TRIMLESS MODELS FEATURE NEW DESIGN AND MAY BE INSTALLED BEFORE DRYWALL - SEE SUBMITTAL AND INSTALLATION INFORMATION\*ADD 5/8" FOR CABINETS WITH ALUMINUM FRAMES.

\*\*COSMIC 20 & GALAXY 20 EXTINGUISHER MUST BE MOUNTED ON THE BACK OF THE CABINET TUB.





## CLEAR VU SERIES: ACRYLIC BUBBLE CABINET IN ALUMINUM, STEEL, STAINLESS, BRONZE OR BRASS

**Door and Trim Construction:** Cold rolled steel with white powder coat finish, #4 stainless steel, clear anodized aluminum, US10 satin bronze, or US3 polished brass. Flush cabinet doors with a 5/8" door stop are attached by a continuous hinge and equipped with zinc-plated handle and roller catch.

**Bubble:** Acrylic bubble allows 180° extinguisher visibility. 2 1/2" projection for 1500 Series, 3 1/2" projection for 2500 and 4500 Series.

**Trim Style and Depth:** Recessed - 3/8" flat trim, Semi-Recessed - 1 1/4", 1 1/2" Square Edge and 2 1/2" or, 3" Rolled Edge. Surface-mount has a square edge or optional rolled edge for steel or stainless steel upon request. 1 3/4" face trim on frame and 1 1/4" trim on door. 2527 rolled edge constructed of aluminum extrusions.

**Tub:** Constructed of cold rolled steel with white powder-coat finish standard. Extinguisher must be mounted to back of tub using bracket.

**Fire-Rated Option Available:** Yes

### Door Styles w/Pull

**F** Full Glazing

**G** Full Glazing & SAF-T-LOK™

### Options at Additional Cost

Aluminum Tub for Aluminum Cabinets Only (Non-Rated Use)

Color Painted Tub (Red or Black)

Color Dark Anodized Aluminum

Vertical or Horizontal Lettering. See Page 21.

Futura Embossed "Fire" Handle - Mill or White

Engraved Metal Door or Etched Glass

US 9 Bright Polished Bronze

US 4 Satin Brass

US 10B Dark Oxidized Oil-Rubbed Bronze

Wall Signs and Alarms. See Page 20

### Bubble

**25** Clear Acrylic

**26** Red Acrylic\*

**27** Bronze Acrylic

\*for 1500 models only

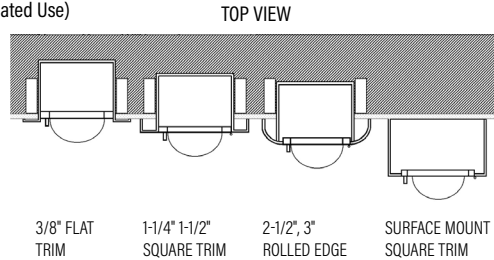

CLEAR VU  
1537G25  
WITH SAF-T-LOK™

Door Material and Series #						Tub I.D.			Frame O.D.			Wall Opening: Non-Rated			Wall Opening: FX2 Option			Accommodates Following Extinguishers
Steel	Aluminum*	Stainless Steel	Bronze	Brass	Trim Style	A	B	C	E	F	W	H	D	W	H	D		
1515	1525	1535	1545	1555	Flat Trim	10 1/2	24	4	13 7/8	27 3/8	11 1/2	25	3 7/8	12 13/16	26 5/16	4 15/16	Cosmic & Galaxy 2.5-10, Mercury 2.5-5, Sentinel 5	
1516	1526	1536	1546	1556	1 1/2" Square	10 1/2	24	4	13 7/8	27 3/8	11 1/2	25	2 5/8	12 13/16	26 5/16	3 11/16		
1517	1527	1537	1547	1557	3" Rolled	10 1/2	24	4	13 7/8	27 3/8	11 1/2	25	1 1/8	12 13/16	26 5/16	2 3/16		
1513	1523	1533	1543	1553	Surf. Mtd.	13 11/16	27 3/16	4 5/8	13 7/8	27 3/8	--	--	--	--	--	--		
2515	2525	2535	2545	2555	Flat Trim	14	30	4	17 3/8	33 3/8	15	31	3 7/8	16 5/16	32 5/16	4 15/16	Cosmic & Galaxy 2.5-10, Cosmic 20A, Mercury 2.5-15 (FM1A & 15A), Sentinel 5, Saturn 15-25, Grenadier P	
2516	2526	2536	2546	2556	1 1/4" Square	14	30	4	17 3/8	33 3/8	15	31	2 7/8	16 5/16	32 5/16	3 15/16		
2517	2527*	2537	--	--	2 1/2" Rolled	14	30	4	17 3/8	33 3/8	15	31	1 5/8*	16 5/16	32 5/16	2 11/16*		
2513	2523	2533	2543	2553	Surf. Mtd.	17 3/16	33 3/16	4 5/8	17 3/8	33 3/8	--	--	--	--	--	--		
4515	4525	4535	--	--	Flat Trim Double Door	28	30	4	31 3/8	33 3/8	29	31	3 7/8	--	--	--	Two each Cosmic & Galaxy 2.5-10, Mercury 2.5-15 (FM1A & 15A), Sentinel 5, Grenadier P	
4513	4523	4533	--	--	Surf. Mtd. Double Door	31 3/16	33 3/16	4 5/8	31 3/8	33 3/8	--	--	--	--	--	--		

Dimensions in Inches

\*ADD 5/8" TO WALL DEPTH FOR A CABINET WITH AN ALUMINUM FRAME. 4500 SERIES CONSIST OF A DOUBLE DOOR DESIGN.

## SMB SERIES: SURFACE-MOUNTED ACRYLIC BUBBLE AND STEEL CABINET

**Door and Trim Construction:** Cold rolled steel with six standard powder-coated colors to choose from - black, white, red, bronze, brass, silver or gray hammertone. Flush cabinet doors with a 5/8" door stop are attached by a continuous hinge and equipped with zinc-plated handle and roller catch. Custom powder-coat finishes available upon request. See page 24.

**Bubble:** Acrylic bubble allows 180° extinguisher visibility. 2-1/2" projection.

**Trim Style and Depth:** This surface-mounted cabinet has a 3" rolled edge that forms a tub. 3" deep tub constructed of cold rolled steel with white powder-coat finish standard. 1 3/4" face trim on frame and 1 1/4" trim on door.

**Extinguisher:** Extinguisher must be mounted to back of tub using bracket.

**Fire-Rated Option Available:** No

**Options at Additional Cost:** Vertical or Horizontal Lettering. See Page 21.

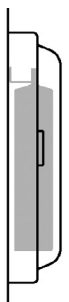

SMB-W25  
WHITE



SMB-BRA27  
BRASS



SMB-H25  
GRAY HAMMERTONE

### Door Finishes

**B** Black  
**W** White  
**R** Red  
**GH** Gray Hammertone  
**BR** Bronze  
**BRA** Brass  
**SI** Silver

### Door Glazing

**25** Clear Acrylic  
**26** Red Acrylic  
**27** Bronze Acrylic

Model	White	Hammertone	Brass	Bronze	Silver	Red	Black	Frame Inside Dimensions	Frame Outside Dimensions	Accommodates Following Extinguishers
SMB-W	SMB-GH	SMB-BRA	SMB-BR	SMB-SA	SMB-R	SMB-B	13 13/16 x 27 5/16	13 15/16 x 27 7/16	Cosmic & Galaxy 2.5-10, Mercury 2.5-5	

Dimensions in Inches



# FIRE EXTINGUISHER CABINETS

## EMBASSY SERIES: DECORATIVE TRIMLESS RECESSED CABINET

**Door and Trim Construction:** These 7/8" formed design cabinet doors are available in # 4 satin stainless steel, US 10 satin bronze, US 3 polished brass, clear anodized aluminum or white powder coated steel. Doors feature two concealed hinges and concealed handle and roller catch.

**Trim Style and Depth:** None

**Tub:** Constructed of cold rolled steel with white powder-coat finish standard.

**Unique Options:** The 5900 Series is equipped with a shelf 12" from the bottom. Knockouts are located 6" from the bottom and 4 1/4" from the back on both the right- and left-hand sides.

**Fire-Rated Option Available:** Yes



EMBASSY 5634S21FX2



EMBASSY 5654V15

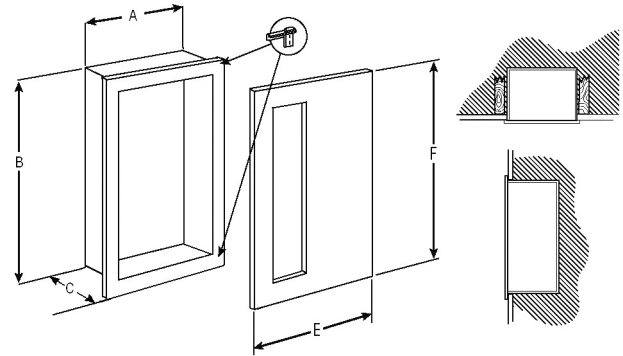

### Door Styles

- S21** Solid
- L22** Solid & SAF-T-LOK™
- V** Vertical Duo
- W** Vertical Duo & SAF-T-LOK™

### Door Glazing

- 10** Clear Acrylic
- 13** Clear Wire Glass w/ Safety Film
- 15** Bronze Acrylic
- 16** Gray Acrylic
- 17** Clear Tempered Glass
- 18** Laminated Safety Glass

### Options at Additional Cost

- Color Painted Door or Tub - Steel Only
- Vertical or Horizontal Lettering. See Page 21
- Futura Embossed "Fire" Handle - Mill or White
- Wall Signs and Alarms, See Page 20
- Color Anodized Aluminum, See Page 24
- #6 Satin, #7 Polished, #8 Mirror Stainless

- US9 Polished Bronze Door - Clear Coated
- US10B Oil-Rubbed Bronze Door
- US4 Satin Brass Door - Clear Coated
- Etched Lettering in Glass, Engraved Lettering

Door Material and Series #					Tub I.D.			Door O.D.*		Wall Opening: Non-Rated			Wall Opening: FX2 Option			Accommodates Following Extinguishers & Valves
Steel	Aluminum	Stainless Steel	Bronze	Brass	A	B	C	E	F	W	H	D	W	H	D	
5614	5624	5634	5644	5654	10 1/2	24	5-3/4	12 3/4 13 3/4 FX2	26 1/4 27 1/4 FX2	11 1/2	25	5 7/8	12 13/16	26 5/16	6 15/16	Cosmic & Galaxy 2.5-10, Mercury 2.5-5, Sentinel 5
5714	5724	5734	5744	5754	16	32	7 3/4	18 1/4 19 1/4 FX2	34 1/4 35 1/4 FX2	17	33	7 7/8	18 5/16	34 5/16	8 15/16	Any Cosmic*, Galaxy, Mercury, Saturn or Grenadier P, Sentinel 5-15, 272
<b>Fire Department Valve, Hose &amp; Extinguisher Cabinets</b>																
5514	5524	5534	5544	5554	18	18	7 3/4	20 1/4 21 1/4 FX2	20 1/4 21 1/4 FX2	19	19	7 7/8	20 5/16	20 5/16	8 15/16	1-1/2" or 2-1/2" Fire Department Valve Left & Right K.O.'s 9" from top, 4" from back**†
5814	5824	5834	--	--	32	32	7 3/4	34 1/4 35 1/4 FX2	34 1/4 35 1/4 FX2	33	33	7 7/8	34 5/16	34 5/16	8 15/16	1-1/2" or 2-1/2" Rack Unit & 2-1/2" Fire Department Valve or Extinguisher. Left K.O. 4" from back, top & bottom.**†
5914	5924	5934	5944	5954	16	40	8 3/4	18 1/4 19 1/4 FX2	42 1/4 43 1/4 FX2	17	41	8 7/8	18 5/16	42 5/16	9 15/16	2-1/2" Fire Department Valve & Fire Extinguisher Any Cosmic, Galaxy, Mercury, Saturn or Grenadier P, Sentinel 5 & 10
<b>Dimensions in Inches</b>																

\*COSMIC & GALAXY 20 EXTINGUISHER MUST BE MOUNTED ON THE BACK OF THE CABINET TUB.

\*\*KNOCKOUTS NOT AVAILABLE STAINLESS TUBS

†KNOCKOUTS NOT AVAILABLE ON FIRE-RATED CABINETS

♿ ALL MODELS SHOWN ON THIS PAGE MEET THE ADA 4" PROJECTION REQUIREMENT



## CAVALIER SERIES: DECORATIVE BRONZE OR BRASS CABINET

**Door and Trim Construction:** Standard finishes are US10 satin bronze or US3 polished brass. Flush cabinet doors with a 5/8" door stop are attached by a continuous hinge and equipped with zinc-plated handle and roller catch.

**Trim Style and Depth:** Recessed - 3/8" flat trim. Semi-Recessed - 1 1/4", 1 1/2" Square Edge or 3" Rolled Edge. Surface-mount has a square edge. 1 3/4" face trim on frame and 1 1/4" trim on door.

**Tub:** Constructed of cold rolled steel with white powder-coat finish standard. Surface mounted models have brass or bronze tubs.

**Unique Options:** Large selection of Bronze and Brass finishes.

**Fire-Rated Option Available:** Yes

### Door Styles w/Pull

- F** Full Glazing
- G** Full Glazing & SAF-T-LOK™
- D** Horizontal Duo Panel
- E** Horizontal Duo Panel & SAF-T-LOK™
- S21** Solid
- L22** Solid & SAF-T-LOK™
- L24** Solid with Cylinder Lock & No Handle
- B10** Solid with 2" x 4" Acrylic Insert & SAF-T-LOK™
- V** Vertical Duo
- W** Vertical Duo & SAF-T-LOK™

### Door Glazing

- 10** Clear Acrylic
- 13** Clear Wire Glass w/ Safety Film
- 15** Bronze Acrylic
- 16** Gray Acrylic
- 17** Clear Tempered Glass
- 18** Laminated Safety Glass

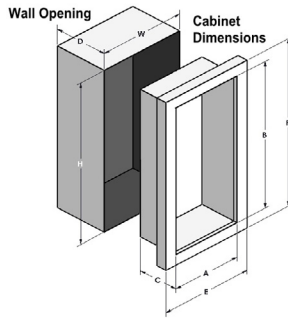

TOP VIEW

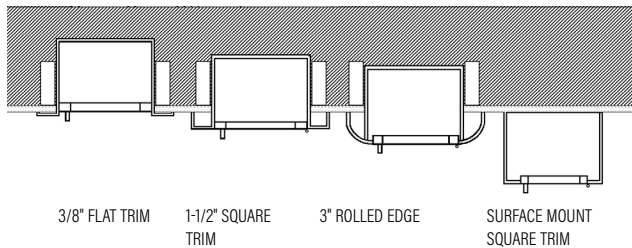

1845W10



1085 (US10B BRONZE)  
FINISH & WHITE LETTERING



1047S21



1857V10

### Options at Additional Cost

- Vertical or Horizontal Lettering - See Page 21
- Futura Embossed "Fire" Handle in Mill, White or Red
- Pulls - Flush, Bronze, Brass. See page 20
- Wall Signs, Labels & Alarms- See Page 20
- Panorama-Style Full Acrylic Door - See page 8
- Optional Standard Color Frame/Door/Tub - see Page 24
- Optional Color tub - see page 24
- Etched Glass Lettering See page 21
- Bronze: US9 Bright Polished, US10B Oil-rubbed Finishes
- Brass: US4 Satin Finish

Trim and Door Material and Series #				Tub I.D.			Trim O.D.*		Wall Opening: Non-Rated			Wall Opening: FX2 Option			Accommodates Following Extinguishers
US10 Satin Bronze	US10B Oil-rubbed	Brass	Trim Style	A	B	C	E	F	W	H	D	W	H	D	
1845	1885	1855	Flat Trim*	10 1/2	24	5 1/2	13 7/8	27 3/8	11 1/2	25	5 3/8	12 13/16	26 5/16	6 7/16	Cosmic & Galaxy 2.5-6, Mercury 2.5 & 5 (Mount 6lb to tub)
1846	1886	1856	1 1/2" Square*	10 1/2	24	5 1/2	13 7/8	27 3/8	11 1/2	25	4 1/8	12 13/16	26 5/16	5 3/16	
1847	1887	1857	3" Rolled*	10 1/2	24	5 1/2	13 7/8	27 3/8	11 1/2	25	2 5/8	12 13/16	26 5/16	3 5/8	
1045	1085	1055	Flat Trim*	10 1/2	24	6	13 7/8	27 3/8	11 1/2	25	5 7/8	12 13/16	26 5/16	6 15/16	Cosmic & Galaxy 2.5-10, Mercury 2.5 & 5, Sentinel 5
1046	1086	1056	1 1/2" Square*	10 1/2	24	6	13 7/8	27 3/8	11 1/2	25	4 5/8	12 13/16	26 5/16	5 11/16	
1047	1087	1057	3" Rolled*	10 1/2	24	6	13 7/8	27 3/8	11 1/2	25	3 1/8	12 13/16	26 5/16	4	
1043	1083	1053	Surf. Mt.	13 11/16	27 3/16	6 1/2	13 7/8	27 3/8	--	--	--	--	--	--	Any Cosmic*, Galaxy, Mercury, Saturn or Grenadier P, Sentinel 5 & 10
2045	2085	2055	Flat Trim*	12g	27	7 3/4	15 3/8	30 3/8	13	28	7 5/8	14 5/16	29 5/16	8 11/16	
2046	2086	2056	1 1/4" Square*	12	27	7 3/4	15 3/8	30 3/8	13	28	6 5/8	14 5/16	29 5/16	7 11/16	
2043	2083	2053	Surf. Mt.	15 3/16	30 3/16	8 1/4	15 3/8	30 3/8	--	--	--	--	--	--	

Dimensions in Inches

\*COSMIC 20 & GALAXY 20 EXTINGUISHER MUST BE MOUNTED ON THE BACK OF THE CABINET TUB.



# FIRE EXTINGUISHER CABINETS

## CLASSIC SERIES: ECONOMICAL FIRE EXTINGUISHER CABINETS

**Tub and Door Frame:** White powder-coated cabinet rust resistant galvanized steel, or aluminum.

**Door:** .060 acrylic front for protection from the elements. Breaker bar and lock standard.

**Options at Additional Cost:** Optional colors. Wall signs and labels, See Page 21.

**Fire-Rated Option:** No

Trim and Door Material New Model#			Previous Model Number	Tub I.D.			Wall Opening			Approx Weight Per Carton	Units Per Carton	Accommodates Following Extinguishers
Gal. Steel	Aluminum	Trim Style		W	H	D	W	H	D			
9163Z30	9123Z30	Surf. Mtd.	99G	8 1/2	19 13/16	6 1/4	--	--	--	16	2	Cosmic & Galaxy 2.5-6, Mercury 2.5-5, Sentinel 5
916AZ30	912AZ30	2 3/4	99GT	8 1/2	19 13/16	6 1/4	9	20 5/16	3 3/4	20	2	
9263Z30	9223Z30	Surf. Mtd.	999G	9 1/2	25 3/4	6 1/4	--	--	--	20	2	Cosmic & Galaxy 2.5-10, Mercury 2.5-5, Sentinel 5
926AZ30	922AZ30	2 3/4	999GT	9 1/2	25 3/4	6 1/4	10	26 1/4	3 3/4	24	2	
936AZ30	932AZ30	4 1/2	104GT	10 1/2	29 3/4	8 1/4	11	30 1/4	4	14	1	Any Cosmic, Galaxy, Mercury, Saturn or Grenadier P, Sentinel 5
9363Z30	9323Z30	Surf. Mtd.	104G	10 1/2	29 3/4	8 1/4	--	--	--	18	1	

Dimensions in Inches



916AZ30



9163Z30 SURFACE MOUNT MODEL

SLIDE TRIM WITH LESS THAN 4" EXPOSURE MEETS ADA REQUIREMENTS.

## ECONOMYLINE SERIES: ECONOMY SURFACE-MOUNTED

**Construction:** Gray Hammertone powder coated cabinet cold rolled steel tub or rust-resistant aluminum.

**Door:** Sliding .060 clear acrylic front with retainer clip. Breaker bar with chain, pre-drilled holes on top lip for padlock.

**Options at Additional Cost:** Other colors, brass padlock, Abus padlock. Wall signs and labels, See Page 21.

**Fire-Rated Option:** No

Trim and Door Material New Model #			Previous Model Number	Tub I.D.			Approx Weight Per Carton	Units Per Carton	Accommodates Following Extinguishers
Steel	Aluminum	Trim Style		W	H	D			
5013N20	5023N20	Surf. Mtd.	818	8 1/8	18	5 1/2	11	2	Cosmic & Galaxy 2.5-6, Mercury 2.5-5
5113N20	5123N20	Surf. Mtd.	924	9 1/8	24	5 1/2	16	2	Cosmic & Galaxy 2.5-10, Mercury 2.5-5, Sentinel 5
5213N20	5223N20	Surf. Mtd.	1028	10 1/8	28	8 1/4	26	2	Any Cosmic, Galaxy, Mercury, Saturn or Grenadier P, Sentinel 5

Dimensions in Inches



ECONOMYLINE 5113N20

## ABS SERIES: DURABLE, SURFACE-MOUNTED ABS PLASTIC

**Construction:** The ABS Series is constructed of injection-molded ABS plastic for a dent, rust and corrosion-proof protection for your fire extinguishers. These impact-resistant cabinets include brass lock, cover and labels.

**Note:** The height dimension includes padlock tab.

**Fire-Rated Option:** No



Model	Tub Size	Cabinet Color	Cover Color	Environment	Accommodates Following Extinguishers
	<b>Height, Width, &amp; Depth</b>				
ABS 16RR	16 x 8 1/2 x 5 3/8	Red	Red	Indoor/Outdoor	Cosmic & Galaxy 2.5-5, Mercury 2.5-5
ABS 16RC	16 x 8 1/2 x 5 3/8	Red	Clear	Indoor	
ABS 16WR	16 x 8 1/2 x 5 3/8	White	Red	Indoor	
ABS 16WC	16 x 8 1/2 x 5 3/8	White	Clear	Indoor	Cosmic & Galaxy 2.5-6, Mercury 2.5-5, Sentinel 5
ABS 20RR	19 1/2 x 9 5/8 x 6 3/8	Red	Red	Indoor/Outdoor	
ABS 20RC	19 1/2 x 9 5/8 x 6 3/8	Red	Clear	Indoor	
ABS 20WR	19 1/2 x 9 5/8 x 6 3/8	White	Red	Indoor	
ABS 20WC	19 1/2 x 9 5/8 x 6 3/8	White	Clear	Indoor	Cosmic 2.5-10, Galaxy 2.5-10, Mercury 2.5-5, Mercury 11 (FM11A), Mercury 15 1/2 (FM15A), Sentinel 5
ABS 24RR	23 1/4 x 9 5/8 x 6 3/8	Red	Red	Indoor/Outdoor	
ABS 24RC	23 1/4 x 9 5/8 x 6 3/8	Red	Clear	Indoor	
ABS 24WR	23 1/4 x 9 5/8 x 6 3/8	White	Red	Indoor	
ABS 24WC	23 1/4 x 9 5/8 x 6 3/8	White	Clear	Indoor	

Dimensions in Inches





## DECORLINE SERIES: ECONOMY STEEL OR ALUMINUM

The Decorline Series offers an Economical Solution for Interior or Exterior Applications. Select from a wide range of sizes that will fit most 2-1/2-10 lb extinguishers. Choose from 2 1/2", 3" or 4 5/8" trim or a surface-mounted design.

**Construction:** Cold rolled steel tub (interior) or aluminum (exterior) with white or gray hammertone powder-coat finish.

**Trim:** Models with trim feature 2" wide trim in either 2.5" or 4.25" depth, depending on model.

**Door:** Models with "AN" designation have slide in acrylic front secured by clips and tab for lock at top. All other models have door with continuous hinges and either solid door or door with acrylic window.

**Fire-rated Option:** No

**Options at Additional Cost:** Brass or Abus Padlock for "AN" models. Optional colors - See page 24. Wall signs and labels - See page 21.



5019G20



521AN20



5017G20



502AN20

Trim & Door		Material and Series #				Tub I.D.			Frame O.D.		Wall Opening			Accommodates Following Extinguishers
Steel	Aluminum	Prev. Model	Door Style	Trim Style	W	H	D	W	H	W	H	D		
631AN20	--	928X	Slide-in Acrylic Front - No Tub	4-3/8" Trim	9 1/8	28	4 1/2	12 1/8	31	9 1/4	28 1/4	--	Cosmic & Galaxy 2.5-5.5, Mercury 2.5-5	
501AN20	502AN20	818T	Slide-in Acrylic Front w/Breaker Bar	2 1/2" Trim	8 1/8	18	5 1/2	11 1/4	21 1/4	9	19	4	Cosmic & Galaxy 2.5-6, Mercury 2.5-5	
511AN20	512AN20	924T		2 1/2" Trim	9 1/8	24	5 1/2	12 1/8	27	10	25	4	Cosmic & Galaxy 2.5-10, Mercury 2.5-5, Sentinel 5	
521AN20	522AN20	1028T		2 1/2" Trim	10 1/8	28	8 1/4	13 1/8	31	11	29	6	Any Cosmic, Galaxy, Mercury, Saturn & Grenadier P, Sentinel 5	
5218N20	5228N20	1028T4		4 5/8" Trim	10 1/8	28	8 1/4	13 1/8	31	11	29	4		
5017F20	5027F20	818TDH	Door w/ Continuous Hinge, Acrylic Window, Handle	3" Trim	8 1/8	18	5 1/2	11 1/4	21 1/4	9	19	3 1/4	Cosmic & Galaxy 2.5-6, Mercury 2.5-5	
5019F20	5029F20	818DH		Surface Mtd.	8 1/8	18	5 1/2	8 1/8	18	--	--	--		
5117F20	5127F20	924TDH		3" Trim	9	23 7/8	5 5/8	12 1/4	27 1/4	10	25	3 1/4	Cosmic & Galaxy 2.5-10, Mercury 2.5-5, Sentinel 5	
5119F20	5129F20	924DH		Surface Mtd.	9	23 7/8	5 5/8	9 1/8	24	--	--	--		
5017G20	5027G20	818TDL	Door w/ Continuous Hinge, Acrylic Window, Handle, Saf-T-Lok	3" Trim	8 1/8	18	5 1/2	11 1/4	21 1/4	9	19	3 1/4	Cosmic & Galaxy 2.5-6, Mercury 2.5-5	
5019G20	5029G20	818DL		Surface Mtd.	8 1/8	18	5 1/2	8 1/8	18	--	--	--		
5117G20	5127G20	924TDL		3" Trim	9	23 7/8	5 5/8	12 1/4	27 1/4	10	25	3 1/4	Cosmic & Galaxy 2.5-10, Mercury 2.5-5, Sentinel 5	
5119G20	5129G20	924DL		Surface Mtd.	9	23 7/8	5 5/8	9 1/8	24	--	--	--		
5017S21	5027S21	818DHS	Solid Door w/ Continuous Hinge, Handle	3" Trim	8 1/8	18	5 1/2	11 1/4	21 1/4	9	19	3 1/4	Cosmic & Galaxy 2.5-6, Mercury 2.5-5	
5019S21	5029S21	818DHS		Surface Mtd.	8 1/8	18	5 1/2	8 1/8	18	--	--	--		
5117S21	5127S21	924DHS		3" Trim	9	23 7/8	5 5/8	12 1/4	27 1/4	10	25	3 1/4	Cosmic & Galaxy 2.5-10, Mercury 2.5-5, Sentinel 5	
5119S21	5129S21	924DHS		Surface Mtd.	9	23 7/8	5 5/8	9 1/8	24	--	--	--		

Dimensions in Inches



# FIRE EXTINGUISHER CABINETS

## LOW PROFILE CABINETS FOR ORBIT FE10V EXTINGUISHERS

**Construction:** Cold rolled steel with white powder-coated finish, anodized aluminum, stainless steel with # 4 finish, US3 polished brass or US10 satin finish bronze.

**Door:** Flush cabinet doors with a 5/8" door stop are attached by a continuous hinge and roller catch. Recessed models are equipped with zinc-plated handle and surface mount have flush pull handle. All models have 1-3/4" wide trim on frame and 1-1/4" trim on doors with glazing. Doors with glazing have clear acrylic glazing.

**Tub:** Constructed of cold rolled steel with white powder-coat finish Tub fits only the Orbit model FE10V (Oval model 10JABC) extinguisher

**Fire-Rated Option:** Yes

### Door Styles

F10 Full Glazing	L22 Solid with Saf-T-Lok™
G10 Full Glazing & saf-t-Lok™	L24 Solid with Cylinder Lock & No Handle
D10 Horizontal Duo Panel	V10 Vertical Duo
E10 Horizontal Duo Panel & saf-t-lok™	W10 Vertical Duo & Saf-T-Lok™
S21 Solid, No Glazing	

### Options at Additional Cost

Futura Embossed "Fire" Handle in Mill, White or Red  
 Wall Signs & Alarms - See Page 20  
 Red, Silver or Black Painted Steel Tub



2115G10

ORBIT LOW PROFILE EXTINGUISHERS

Model #	Material	Trim Style	Tub I.D.			Frame O.D.		Wall Opening			WALL OPENING FX2 OPTION		
			W	H	Depth	W	H	W	H	D	W	H	D
2115	Steel	3/8" Flat Trim	12	27	3-1/4	15-3/8	30-3/8	13	28	3-1/8	14 5/16	29 5/16	4 1/4
2125	Aluminum	3/8" Flat Trim	12	27	3-1/4	15-3/8	30-3/8	13	28	3-1/8	14 5/16	29 5/16	4 1/4
2135	Stainless Steel	3/8" Flat Trim	12	27	3-1/4	15-3/8	30-3/8	13	28	3-1/8	14 5/16	29 5/16	4 1/4
2119	Steel	Surface Mount	15-3/8	30-3/8	3-1/4	15-3/8	30-3/8	--	--	--	--	--	--
2139	Stainless Steel	Surface Mount	15-3/8	30-3/8	3-1/4	15-3/8	30-3/8	--	--	--	--	--	--
2145	US10 Satin Bronze	3/8" Flat Trim	12	27	3-1/4	15-3/8	30-3/8	13	28	3-1/8	14 5/16	29 5/16	4 1/4
2155	US3 Polished Brass	3/8" Flat Trim	12	27	3-1/4	15-3/8	30-3/8	13	28	3-1/8	14 5/16	29 5/16	4 1/4

Dimensions in Inches

## SM SERIES: ECONOMICAL SURFACE-MOUNT ALUMINUM CABINET

**Construction:** All aluminum with white powder coat finish standard. Cabinet is hinged on top and plexiglass front slides in.

**Door:** Full Breakaway Plexiglass, with center pull handle and tamperproof security screws.

**Options:** Other colors - see page 24. TSHS Spanner Tool Head Screwdriver. Wall Signs and Labels - see page 21.

**Fire-Rated Option:** No

### Door Styles

J Center Pull Handle w/ Tamperproof Screws
G Center Pull Handle w/ Cylinder Lock

### Door Glazing

30 Clear Plexiglass



SM6773J

Model #	Previous Model #	Depth of Cabinet	Frame O.D.			Glazing Size			Accommodates Following Extinguishers
			W	H	Projection	W	H	Number	
9123F	6473	6	8 1/2	20	6 1/4	7 3/4	18 11/16	2	Cosmic & Galaxy 2.5-5.5, Mercury 2.5-5
9223F	6573	6	9 1/2	25 3/4	6 1/4	8 3/4	24 1/2	2	Cosmic & Galaxy 2.5-10, Mercury 2.5-5, Sentinel 5
6773F*	SM-20	7 13/16	11	28	8 3/4	10 1/4	27 9/16	2	Any Cosmic, Galaxy, Mercury, Saturn or Grenadier P, Sentinel 5

Dimensions in Inches

\*Only available as J30 option

## FB SERIES: FIBERGLASS FIRE EXTINGUISHER CABINET

**Construction:** Door and tub are UV-resistant fiberglass with high-visibility red finish and 5" x 9" Fire Extinguisher Lettering

**Door:** Gasketed door with 6" x 9" Gasketed view window and corrosion-resistant aluminum handle. All cabinets come standard with a full-length stainless steel hinge attached by rivets. Door is tightly latched against the silicone gasket by (2) stainless steel snap latches.

**Fire-Rated Option:** No

Model	Tub Size I.D.			Outside Dimensions			Fire Extinguishers
	W	H	D	W	H	D	
1353D12	10-1/4	23-1/4	8-1/2	13-1/4	26-1/8	9-3/4	Cosmic and Galaxy 2-1/2-10, Cosmic 20E (FE20C), any Mercury, Saturn 15
1363D12	12-1/2	24-1/8	9	15-3/4	27-1/8	10-1/4	Any Cosmic, Galaxy, Mercury, Saturn 15, Grenadier, Sentinel 5-10
1373D12	16	33	12-3/4	19-5/8	36-1/8	14	Any Cosmic, Galaxy, Mercury, Saturn, Grenadier, Sentinel

Dimensions in Inches





## SECURITY AND DETENTION CABINETS

JL security and detention cabinets for fire extinguishers, fire hoses or fire department valves are constructed to meet maximum security requirements in areas where fire protection is required. All recessed models have heavy-duty masonry anchors welded to the frame.

**Door, Tub and Trim:** 12 gauge steel with white powder coat finish, or 14 gauge #4 satin stainless finish. Flush cabinet doors are mounted in a 1" door stop and attached by a heavy-duty continuous hinge. Choose from 3 standard lock preps, or see lock options below for more choices.

**Trim Style and Depth:** 1-1/4" trim on frame non-rated, 1-1/2" trim on fire-rated frames. Available in Recessed with flat trim, Semi-recessed with 2-1/2" square trim or Surface-mount model with square edge. Heavy duty masonry anchors are welded to frame on all recessed cabinets.

**Lock:** Detention deadlock prep (DDP) provided standard. Optional lock preps at no charge are detention deadlock prep (DDP) or mortise cylinder prep (MCP).

**Fire-Rated Option Available:** Yes.

**Options At Additional Cost:** Vertical or Horizontal Lettering Pg 21, Optional Colors for Steel Cabinets. See Pg 24.

**Lock Options At Additional Cost:** Installed detention deadlock, slam lock, or mortise cylinder. Mortise deadbolt prep (MDP) or with lock installed.



SFC 15 W/DETECTION DEADBOLT



SSFC-37 W/DETECTION DEADBOLT



SVC-13 W/OPTIONAL COLOR

TRIM & DOOR MATERIAL & SERIES			TUB I.D.			*FRAME O.D.			WALL OPENING NON-RATED			WALL OPENING FX2 OPTION			RECOMMENDED EXTINGUISHER, HOSE & RACK
STEEL	STAINLESS	TRIM STYLE	W	H	D	W	H	D	W	H	D	W	H	D	
<b>SECURITY FIRE EXTINGUISHER CABINETS (SFC)</b>															
SFC-11	SSFC-31	Flat Trim	10 1/2	24	7	12 1/2	26	11 1/2	25	7 1/2	12 1/2	26 1/2	8	Cosmic & Galaxy 2.5-10, Mercury 2.5 & 5**	
SFC-12	SSFC-32	2-1/2" Sqr. Trim	10 1/2	24	7	12 1/2	26	11 1/2	25	5	12 1/2	26 1/2	5 1/2		
SFC-13	SSFC-33	Surface Mt. Sq.	13	26-1/2	8	13	26 1/2	--	--	--	--	--	--		
SFC-15	SSFC-35	Flat Trim	12	27	8 1/2	14	29	13	28	9	14	29 1/2	9 1/2	Cosmic & Galaxy 2.5-20, Mercury 2.5-15, Saturn 5, Sentinel 5**	
SFC-16	SSFC-36	2-1/2" Sqr. Trim	12	27	8 1/2	14	29	13	28	6-1/2	14	29 1/2	7		
SFC-17	SSFC-37	Surface Mt. Sq.	14 1/2	29 1/2	10	14 1/2	29 1/2	--	--	--	--	--	--		
<b>SECURITY VALVE CABINETS (SVC)</b>															
SVC-11	SSVC-31	Flat Trim	18	18	8 1/2	20	20	19	19	9	20	20 1/2	9 1/2	1-1/2" or 2-1/2" Fire Department Valve Knockouts 11 & 31: 2 each side - 5" from top, bottom and back. 12 & 32: 2 each side - 4.5" from top, bottom and back †	
SVC-12	SSVC-32	2-1/2" Sqr Trim	18	18	8 1/2	20	20	19	19	6 1/2	20	20 1/2	7		
SVC-13	SSVC-33	Surface Mt. Sq.	20 1/2	20 1/2	10	20 1/2	20 1/2	--	--	--	--	--	--		
<b>SECURITY HOSE CABINETS (SHC)</b>															
SHC-11	SSHC-31	Flat Trim	32 3/4	34 3/4	8	34 3/4	36 3/4	33 3/4	35 3/4	8 1/2	34 3/4	36 3/4	9	1-1/2" or 2-1/2" Hose Rack, & Extinguisher, or Fire Department Valve & Extinguisher Knockouts: 2 each side - 4" from top bottom and back†	
SHC-12	SSHC-32	2-1/2" Sqr. Trim	32 3/4	34 3/4	8	34 3/4	36 3/4	33 3/4	35 3/4	6	34 3/4	36 3/4	6 1/2		
SHC-13	SSHC-33	Surface Mt. Sq.	36 3/4	38 3/4	8	36 3/4	38 3/4	--	--	--	--	--	--		

Dimensions in Inches

\*FIRE RATED CABINETS - ADD 1" TO FRAME OD

\*\*USE JL EXTINGUISHERS ONLY IN THIS CABINET.

†KNOCKOUTS NOT AVAILABLE ON FIRE-RATED CABINETS

## SCHOOL CABINETS

**Door and Trim:** 12 gauge steel or 14 gauge stainless steel door with tempered glass is mounted in a 5/8" door stop, attached by a continuous hinge and equipped with zinc-plated handle.

**Trim Style:** Recessed - Flat Trim. Surface mount and semi-recessed models have a square edge.

**Tub:** 16 gauge steel with white powder-coated primer. Stainless steel models have stainless tub. Masonry anchors standard.

**Options at Additional Cost:** Duo panel or solid door, polycarbonate glazing, Flush pull, SAF-T-LOK, lettering - see page 21.

**Fire-Rated Option Available:** Yes



SCHOOL CABINET CS2015F

Model		Tub I.D.			*Frame O.D.		Wall Opening: Non-Rated			Wall Opening: FX2 Option			Accommodates Following Extinguishers
Steel	Trim Style	W	H	D	W	H	W	H	D	W	H	D	
CS2015	Flat Trim	12	27	7 3/4	14	29	13	28	8	14	29	8 3/4	Any Cosmic, Galaxy, Mercury, Saturn & Grenadier P, Sentinel 5-10
CS2017	2 1/2 Square	12	27	7 3/4	14	29	13	28	5 1/2	14	29	6 1/2	
CS2013	Surf. Mtd.	14 1/2	29 1/2	8	14 1/2	29 1/2	--	--	--	--	--	--	

Dimensions in Inches

\*FIRE RATED CABINETS - ADD 1" TO FRAME OD.



# EMERGENCY SPECIALTIES

## FREESTANDING AED CABINET STAND: 1480 SERIES



This Decorative Stand with a Surface-Mount Steel or Aluminum Cabinet can be an Attractive Addition to a Building's Décor by Coordinating Finishes and Paint Colors.

**Construction:** 52" structural steel tubing and steel baseplate. White epoxy or silver metallic finish standard, with custom colors also available.

## DUAL CABINET FOR AED AND EMERGENCY OXYGEN: OLYMPUS 1900 SERIES

Provide More Lifesaving Equipment by Including Emergency Oxygen with Your AED.

**Door & Trim Construction:** CRS with white powder-coat finish, #4 stainless steel or clear anodized aluminum. 1-3/4" trim on face and door, mounted in a 5/8" door stop and attached by a continuous hinge. All models feature a clear acrylic window with graphics, zinc-plated handle and roller catch.

**Trim Style & Depth:** Surface-mount has a square edge. Recessed - 3/8" flat trim, Semi-Recessed - 1-1/2" square edge or 3" rolled edge.

**Alarm:** 85 db Commander (audible) alarm standard.

**Oxygen:** Accommodates up to "D" size cylinder. Available with patented TxO2 oxygen system that features easy-to-use automatic flow system.

**Tub:** White powder coated CRS. Fire-rated option available.



1913F12

## WEATHER-RESISTANT AED CABINETS: 1463 SERIES

Protect Your AED From Moisture and Dust with this Durable Surface-Mount Cabinet.

**Construction:** This AED cabinet is constructed of galvanized steel and powder coated for a durable, water resistant finish. Stainless steel turn handle and fully gasketed.



1463

## AUTOMATED EXTERNAL DEFIBRILLATORS: LS-AED SERIES

All Defibrillators Meet Local and National Standards for Emergency Care in Public Places and are FDA-Approved. JL has Several Models Available Which All Feature Automatic Heartbeat Detection, Require Minimum Training to Operate and Include a Training Video.

## AED CABINETS TO FIT MOST BRANDS: 1400 LIFESTART SERIES

Designed to Accommodate Most AED's on the Market Today.

**Door & Trim Construction:** CRS with white powder-coat finish, #4 stainless steel or clear anodized aluminum. 1-3/4" trim on face. Formed door with 1-3/4" trim, mounted in a 5/8" door stop with zinc-plated handle and roller catch and continuous hinge. View AED through a clear acrylic window with graphics.

**Trim Style & Depth:** Surface-mount has a square edge. Recessed - 3/8" flat trim, Semi-Recessed - 1-1/2" square edge or 3" rolled edge.

**Alarm:** 85 db Commander (audible) alarm standard.

**Tub:** White powder-coated CRS. Fire-rated available.



1413F12SA

## METAL AED CABINET OPTIONS AND ACCESSORIES

Siren Strobe Alarm and 85 db Alarm for 3" and surf mtd.(9V battery) (SA)

Alarm Connectivity Switch: Magnetic Door contact (14MAG) or Roller Reed Contact (14RR).

Optimal door styles - most FEC styles available.

Saf-T-Clasp for Visual Notification if Door has been Opened (14STC)

Custom Door Graphics

AED Wall Signs

Architectural Bronze or Brass

Custom Sizes & Paint Colors

Fire-Rated Recessed Cabinet - FX2

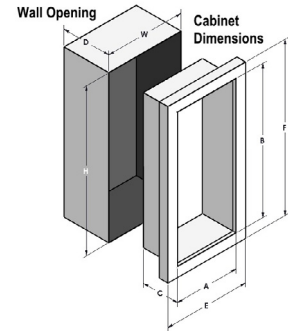

### Lifestart Series for Any Brand AED

Trim and Door Material and Series #				Tub I.D.			Frame O.D.		Wall Opening Non-Rated			Wall Opening Fire-Rated Option		
Steel	Aluminum	Stainless Steel	Trim Style	A	B	C	E	F	W	H	D	W	H	D
1415F12	1425F12	1435F12	3/8 Flat Trim	14	14	6 3/4	17 3/8	17 3/8	15 1/4	15 1/4	6 1/2	16 5/16	16 5/16	7 11/16
1416F12	1426F12	1436F12	1 1/2 Square	14	14	6 3/4	17 3/8	17 3/8	15 1/4	15 1/4	5 7/8	16 5/16	16 5/16	6 7/16
1417F12	1427F12	1437F12	3or 2 1/2"Rolled	14	14	6 3/4	17 3/8	17 3/8	15 1/4	15 1/4	3 3/4*	16 5/16	16 5/16	4 15/16*
1413F12	1423F12	1439F12	Surf. Mtd.	17 3/16	17 3/16	7	17 3/8	17 3/8	-	-	-	-	-	-

Dimensions in Inches

\* MODEL 1427 HAS 2-1/2" TRIM & REQUIRES 5/8" DEEPER WALL OPENING

### The New Side-by-Side Olympus Series for AED & Extinguisher or Oxygen

Trim and Door Material and Series #				Tub I.D.			Frame O.D.		Wall Opening Non-Rated			Wall Opening Fire-Rated Option		
Steel	Aluminum	Stainless Steel	Trim Style	W	H	D	E	F	W	H	D	W	H	D
1915F12	1925F12	1935F12	3/8 Flat Trim	18	18	8	21 3/8	21 3/8	19	19	8	20 5/16	20 5/16	8 15/16
1916F12	1926F12	1936F12	1 1/2 Square	18	18	8	21 3/8	21 3/8	19	19	6 7/8	20 5/16	20 5/16	7 11/16
1917F12	1927F12	1937F12	3 Rolled	18	18	8	21 3/8	21 3/8	19	19	5 3/4*	20 5/16	20 5/16	6 3/16*
1913F12	1923F12	1939F12	Surf. Mtd.	21 3/16	21 3/16	8 1/2	21 3/8	21 1/8	-	-	-	-	-	-

Dimensions in Inches

\* MODEL 1927 HAS 2-1/2" TRIM & REQUIRES 5/8" DEEPER WALL OPENING





## FIRE HOSE EQUIPMENT CABINET

This durable Storage Cabinet has CRS Steel or Galvanized Steel Construction for Interior or Exterior Use. The top is angled with a 3" overhang to shed water.

**Construction:** 16 gauge galvanized or cold rolled steel construction. Both are finished with red powder-coat paint and features shelf and louvers on both sides of cabinet for ventilation. Top is slightly angled and overhangs the doors by 2-7/8". Optional 12" legs.

**Hardware:** Hasp for a padlock (by others) standard.

**Size:** 58" W x 42" H x 18 1/2" D

**Options:** DFFH or 1403 "Fire Hose" Decal, Locking chrome handle with top & bottom latching, (must be ordered with cabinet in order to install rod latching system)

**Models:**

**HECIG:** Galvanized

**HECIGL:** Galvanized with Legs

**HECIR:** Steel

**HECIRL:** Steel with Legs

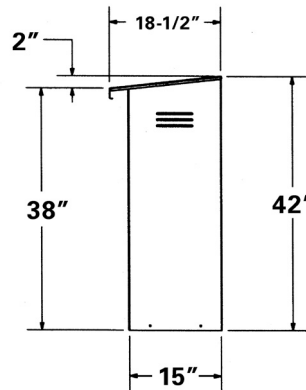

HECIGL OR HECIRL



HECIG OR HECIR

## HRA SERIES: FIRE HOSE RACK ASSEMBLY

**Operation:** One-man operation for immediate means of fire control.

**Ratings:** 100 GPM at 65 PSI at the nozzle. Hose is FM-approved, Industrial Fog Nozzle, Angle Valve and Pin Rack are UL-rated. Models HRA050B-HRA100CH rated for Class II Service under NFPA/FEMA Class of service. Models HRA050B-2.5 - HRA100B-2.5 rated for Class II and Class III Service under NFPA/FEMA Class of service.

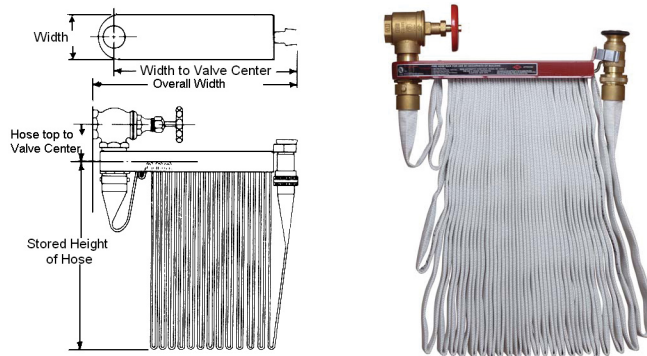

Model #	Prev. Model #	Hose Length	Hose Diameter	Hose Type	Valve Size	Rack Length	Class of Service	Stored Height of Hose	Width of Rack	Height from Hose Top to Valve Center	Overall Width of Stored Unit to Valve Center
<b>Basic Unit For 1 1/2" Hose and Valve with Single Jacket Lined Hose, Industrial Fog Nozzle, Red Enamel Pin Rack and Cast Brass Coupling, Angle Valve, Escutcheon and Nipple</b>											
HRA050B	3005	50'	1 1/2	Poly Lined Hose	1 1/2	17 7/8	II	23	4 1/8	3 7/8	19 3/4
HRA075B	3007	75'	1 1/2		1 1/2	17 7/8	II	23	4 1/8	3 7/8	19 3/4
HRA100B	3010	100'	1 1/2		1 1/2	17 7/8	II	23	4 1/8	3 7/8	19 3/4
<b>Basic Unit Above, with Red Enamel Rack, Chrome-plated Brass Fittings and Chrome-plated Rough Brass Valve</b>											
HRA050CH	3105	50'	1 1/2	Poly Lined Hose	1 1/2	17 7/8	II	23	4 1/8	3 7/8	19 3/4
HRA075CH	3107	75'	1 1/2		1 1/2	17 7/8	II	23	4 1/8	3 7/8	19 3/4
HRA100CH	3110	100'	1 1/2		1 1/2	17 7/8	II	23	4 1/8	3 7/8	19 3/4
<b>Basic Unit For 1 1/2" Hose and 2 1/2" Valve with Single Jacket Lined Hose, Industrial Fog Nozzle, Red Enamel Pin Rack and Cast Brass Coupling, Angle Valve, Reducer, Escutcheon and Nipple</b>											
HRA050B-2.5	3205	50'	1 1/2	Poly Lined Hose	2 1/2	17 7/8	II and III	23	4 1/8	4 1/8	20 1/16
HRA075B-2.5	3207	75'	1 1/2		2 1/2	17 7/8	II and III	23	4 1/8	4 1/8	20 1/16
HRA100B-2.5	3210	100'	1 1/2		2 1/2	17 7/8	II and III	25	4 1/8	4 1/8	20 1/16
HRA125B-2.5	3212	125'	1 1/2		2 1/2	17 7/8	II and III	28	4 1/8	4 1/8	20 1/16
<b>SEE CROWLINE SERIES FOR CABINETS TO FIT FIRE HOSE RACK ASSEMBLIES</b>											
Dimensions in Inches											



# FIRE HOSE AND VALVE CABINETS

## CROWNLINE 6000-7200 SERIES: CABINETS FOR FIRE HOSES AND EXTINGUISHERS

## CROWNLINE 8000 SERIES: CABINETS FOR FIRE DEPARTMENT VALVES

**Door and Trim:** #4 stainless steel, clear anodized aluminum or cold rolled steel with white powder-coat finish standard. 1 3/4" face trim on frame and 1 1/4" trim on door. These flush cabinet doors mounted in a 5/8" door stop, attached by a continuous hinge and equipped with zinc-plated handle and roller catch

**Trim Style and Depth:** Trimless Recessed - for 5/8" depth drywall or 3/4" plaster. Recessed - 3/8" flat trim. Semi-recessed 1 1/4" Square Edge or 2 1/2" Rolled Edge. Rolled edge aluminum trim is formed of extrusions. Surface mount steel and aluminum have square edge, stainless models have rolled edge with galvanized back wall. Tub of steel and aluminum surface-mounted models are same material as trim.

**Tub:** White powder-coated cold rolled steel. Surface-mounted stainless steel models feature a galvanized back panel.

**Fire-Rated Option Available:** Yes



6517V10  
SHOWN IN OPTIONAL RED FINISH



6337F10



6325A10  
WITH SAF-T-LOK™



6514B10FX2  
WITH SAF-T-LOK™



8016F10

### Door Styles with Pull

- F Full Glazing
- G Full Glazing & Saf-T-Lok™
- D Horizontal Duo Panel
- E Horizontal Duo Panel & Saf-T-Lok™
- S21 Solid
- L22 Solid with SAF-T-LOK™
- L24 Solid with Cylinder Lock & No Handle
- B10 Solid with Acrylic Insert & Saf-T-Lok™
- V Vertical Duo
- W Vertical Duo & Saf-T-Lok™
- A Center Duo Panel with Saf-T-Lok™

### Door Glazing

- 10 Clear Acrylic
- 13 Clear Wire Glass w/Safety Film
- 15 Bronze Acrylic
- 16 Gray Acrylic
- 17 Tempered Glass
- 18 Laminated Safety Glass

### Options at Additional Cost

- Aluminum Tub for Non-Rated Use
- Vertical or Horizontal Lettering - Pg 21
- Futura Embossed "Fire" Handle in Mill, White or Red
- Flush Pull
- Stainless Steel Tub #4 Satin Finish (Knockouts not available)
- Wall Signs & Labels - Pg 21
- Color Anodized Aluminum - Pg 24
- Optional Standard Color Frame/Door/Tub - Pg 24
- Custom Color Frame/Door/Tub
- Alarms - Pg 20
- 12 Gauge Security Cabinets - See Pg. 15
- Custom Stainless Finishes # 6 Satin, #7 Polished, #8 Mirror
- Brass or Bronze Finishes - See Embassy Series Pg. 10

### TOP VIEW

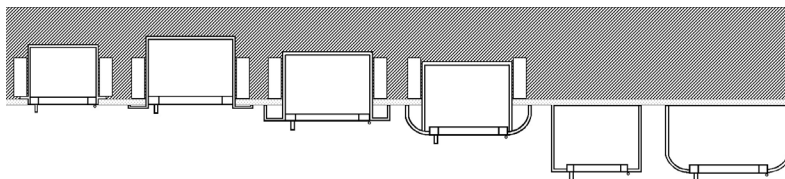

- TRIMLESS RECESSED FLANGE FOR 5/8" DRYWALL OR 3/4" PLASTER
- 3/8" FLAT TRIM
- 1-1/2" SQUARE TRIM
- 2-1/2", 3" ROLLED EDGE
- SURFACE MOUNT SQUARE TRIM
- SURFACE MOUNT OPTIONAL ROLLED EDGE

**Knockouts:** Hose Cabinet Knockouts for Recessed and Semi-Recessed Models: Knockouts (K.O.s) are provided centered, one, side, top and bottom—other side offset, top and bottom. Cabinets with 6" depth will have K.O.'s centered. Trimless K.O.s centered only—no offset. For surface-mount cabinets knockouts are provided only when exact location is known. **See submittal for K.O. locations of each model.**

K.O.s are not provided on FIRE-FX2 cabinets or stainless tubs. Instructions for the knockouts in the field are provided and must be strictly adhered to maintain fire-rating. 8000 Series Cabinets can be ordered without shelf allow for lower mounting height of valve piping to meet NFPA10

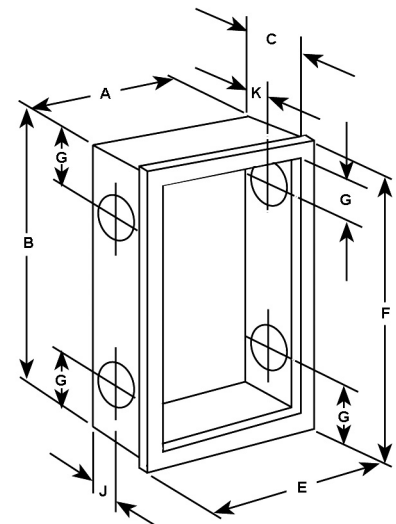

# FIRE HOSE AND VALVE CABINETS



Trim and Door Material and Series Number				Tub I.D.			Frame O.D.		Wall Opening: Non-Rated			Wall Opening: Fire-Rated			Recommended Hose Rack, Valve, and Extinguishers
Steel	Aluminum	Stainless Steel**	Trim Style	A	B	C	E	F	W	H	D	W	H	D	
<b>Hose with Extinguisher or FD Valve Cabinets</b>															
6014	6024	6034	Trimless 5/8" Drywall ‡	24	30	6	27 1/8	33 1/8	25	31	6 1/8	26 5/16	32 5/16	6 11/16	<b>HOSE RACK &amp; EXTINGUISHER:</b> 1- 1/2" x 1-1/2" Hose Rack Unit -50 or 75' Hose (HRA050B, HRA050CH, HRA075B, HRA075CH) & Cosmic 2 1/2 or Galaxy 2 1/2 - 5 lb Extinguisher
6015	6025	6035	Flat Trim	24	30	6	27 3/8	33 3/8	25	31	5 7/8	26 5/16	32 5/16	6 15/16	
6016	6026	6036	1 1/4" Square	24	30	6	27 3/8	33 3/8	25	31	4 7/8	26 5/16	32 5/16	5 15/16	
6017	6027	6037	2 1/2" Rolled	24	30	6	27 3/8	33 3/8	25	31	3 5/8*	26 5/16	32 5/16	4 11/16*	
6013	6023	6039	Surf. Mtd.	27 3/16	33 3/16	6 1/2	27 3/8	33 3/8	--	--	--	--	--	--	
6214	6224	6234	Trimless 5/8" Drywall ‡	24	34 3/4	6	27 1/8	37 7/8	25	35 3/4	6 1/8	26 5/16	37 1/16	6 11/16	<b>HOSE RACK:</b> 1- 1/2" x 1-1/2" Hose Rack Unit - 100' Hose (HRA100B or HRA100CH) & Cosmic 2 1/2 or Galaxy 2 1/2 - 5 lb Extinguisher
6215	6225	6235	Flat Trim	24	34 3/4	6	27 3/8	38 1/8	25	35 3/4	5 7/8	26 5/16	37 1/16	6 15/16	
6216	6226	6236	1 1/4" Square	24	34 3/4	6	27 3/8	38 1/8	25	35 3/4	4 7/8	26 5/16	37 1/16	5 15/16	
6217	6227	6237	2 1/2" Rolled	24	34 3/4	6	27 3/8	38 1/8	25	35 3/4	3 5/8*	26 5/16	37 1/16	4 11/16*	
6213	6223	6239	Surf. Mtd.	27 3/16	37 15/16	6 1/2	27 3/8	38 1/8	--	--	--	--	--	--	
6114	6124	6134	Trimless 5/8" Drywall ‡	24	30	8	27 1/8	33 1/8	25	31	8 1/8	26 5/16	32 5/16	8 11/16	<b>HOSE RACK:</b> 2-1/2" x 1-1/2" Hose Rack Unit 50 or 75' Hose (HAA050B-2.5 OR HRA075B-2.5)
6115	6125	6135	Flat Trim	24	30	8	27 3/8	33 3/8	25	31	7 7/8	26 5/16	32 5/16	8 15/16	
6116	6126	6136	1 1/4" Square	24	30	8	27 3/8	33 3/8	25	31	6 7/8	26 5/16	32 5/16	7 15/16	
6117	6127	6137	2 1/2" Rolled	24	30	8	27 3/8	33 3/8	25	31	5 5/8*	26 5/16	32 5/16	6 11/16*	
6113	6123	6139	Surf. Mtd.	27 3/16	33 3/16	8 1/2	27 3/8	33 3/8	--	--	--	--	--	--	
6414	6424	6434	Trimless 5/8" Drywall ‡	24	34 3/4	8	27 1/8	37 7/8	25	35 3/4	8 1/8	26 5/16	37 1/16	8 11/16	<b>HOSE RACK:</b> 2-1/2" x 1-1/2" Hose Rack Unit 100' Hose (HRA 100B-2.5)
6415	6425	6435	Flat Trim	24	34 3/4	8	27 3/8	38 1/8	25	35 3/4	7 7/8	26 5/16	37 1/16	8 15/16	
6416	6426	6436	1 1/4" Square	24	34 3/4	8	27 3/8	38 1/8	25	35 3/4	6 7/8	26 5/16	37 1/16	7 15/16	
6417	6427	6437	2 1/2" Rolled	24	34 3/4	8	27 3/8	38 1/8	25	35 3/4	5 5/8*	26 5/16	37 1/16	6 11/16*	
6413	6423	6439	Surf. Mtd.	27 3/16	37 15/16	8 1/2	27 3/8	38 1/8	--	--	--	--	--	--	
6614	6624	6634	Trimless 5/8" Drywall ‡	24	38 3/4	8	27 1/8	41 7/8	25	39 3/4	8 1/8	26 5/16	41 1/16	8 11/16	<b>HOSE RACK:</b> 2-1/2" x 1-1/2" Hose Rack Unit 125' Hose (HRA 125B-2.5)
6615	6625	6635	Flat Trim	24	38 3/4	8	27 3/8	42 1/8	25	39 3/4	7 7/8	26 5/16	41 1/16	8 15/16	
6616	6626	6636	1 1/4" Square	24	38 3/4	8	27 3/8	42 1/8	25	39 3/4	6 7/8	26 5/16	41 1/16	7 15/16	
6617	6627	6637	2 1/2" Rolled	24	38 3/4	8	27 3/8	42 1/8	25	39 3/4	5 5/8*	26 5/16	41 1/16	6 11/16*	
6613	6623	6639	Surf. Mtd.	27 3/16	41 15/16	8 1/2	27 3/8	42 1/8	--	--	--	--	--	--	
6314	6324	6334	Trimless 5/8" Drywall ‡	30	30	8	33 1/8	33 1/8	31	31	8 1/8	32 5/16	32 5/16	8 11/16	<b>HOSE RACK &amp; FD VALVE OR EXTINGUISHER:</b> 1-1/2" OR 2-1/2" Valve, Unit Plus An Extinguisher (Except Sentinel 10-20, 272)
6315	6325	6335	Flat Trim	30	30	8	33 3/8	33 3/8	31	31	7 7/8	32 5/16	32 5/16	8 15/16	
6316	6326	6336	1 1/4" Square	30	30	8	33 3/8	33 3/8	31	31	6 7/8	32 5/16	32 5/16	7 15/16	
6317	6327	6337	2 1/2" Rolled	30	30	8	33 3/8	33 3/8	31	31	5 5/8*	32 5/16	32 5/16	6 11/16*	
6313	6323	6339	Surf. Mtd.	33 3/16	33 3/16	8 1/2	33 3/8	33 3/8	--	--	--	--	--	--	
6514	6524	6534	Trimless 5/8" Drywall ‡	32 3/4	34 3/4	8	35 7/8	37 7/8	33 3/4	35 3/4	8 1/8	35 1/16	37 1/16	8 11/16	<b>HOSE RACK &amp; FD VALVE OR EXTINGUISHER:</b> 1-1/2" OR 2-1/2" Valve, 100' Hose Rack Unit Plus FD Valve or Extinguisher (Not Sentinel 20, 272)
6515	6525	6535	Flat Trim	32 3/4	34 3/4	8	36 1/8	38 1/8	33 3/4	35 3/4	7 7/8	35 1/16	37 1/16	8 15/16	
6516	6526	6536	1 1/4" Square	32 3/4	34 3/4	8	36 1/8	38 1/8	33 3/4	35 3/4	6 7/8	35 1/16	37 1/16	7 15/16	
6517	6527	6537	2 1/2" Rolled	32 3/4	34 3/4	8	36 1/8	38 1/8	33 3/4	35 3/4	5 5/8*	35 1/16	37 1/16	6 11/16*	
6513	6523	6539	Surf. Mtd.	35 15/16	37 15/16	8 1/2	36 1/8	38 1/8	--	--	--	--	--	--	
7214	7224	7234	Trimless 5/8" Drywall ‡	32 3/4	38 3/4	8	35 7/8	41 7/8	33 3/4	39 3/4	8 1/8	35 1/16	41 1/16	8 11/16	<b>HOSE RACK &amp; FD VALVE OR EXTINGUISHER:</b> 1-1/2" OR 2-1/2" Valve, 125' Hose Rack Unit Plus FD Valve or Extinguisher (Not Sentinel 20, 272)
7215	7225	7235	Flat Trim	32 3/4	38 3/4	8	36 1/8	42 1/8	33 3/4	39 3/4	7 7/8	35 1/16	41 1/16	8 15/16	
7216	7226	7236	1 1/4" Square	32 3/4	38 3/4	8	36 1/8	42 1/8	33 3/4	39 3/4	6 7/8	35 1/16	41 1/16	7 15/16	
7217	7227	7237	2 1/2" Rolled	32 3/4	38 3/4	8	36 1/8	42 1/8	33 3/4	39 3/4	5 5/8*	35 1/16	41 1/16	6 11/16*	
7213	7223	7239	Surf. Mtd.	35 15/16	41 15/16	8 1/2	36 1/8	42 1/8	--	--	--	--	--	--	
<b>Fire Department Cabinets</b>															
8514	8524	8534	Trimless 5/8" Drywall ‡	18	18	8	21 1/8	21 3/8	19	19	8 1/8	20 5/16	20 5/16	8 11/16	<b>FIRE DEPARTMENT VALVE 1-1/2" or 2-1/2" Fire Department Valve with Cap and Chain</b>
8515	8525	8535	Flat Trim	18	18	8	21 3/8	21 3/8	19	19	7 7/8	20 5/16	20 5/16	8 15/16	
8516	8526	8536	1 1/4" Square	18	18	8	21 3/8	21 3/8	19	19	6 7/8	20 5/16	20 5/16	7 15/16	
8517	8527	8537	2 1/2" Rolled	18	18	8	21 3/8	21 3/8	19	19	5 5/8*	20 5/16	20 5/16	6 11/16*	
8513	8523	8539	Surf. Mtd.	21 3/16	21 3/16	8 1/2	21 3/8	21 3/8	--	--	--	--	--	--	
8414	8424	8434	Trimless 5/8" Drywall ‡	18	18	10	21 1/8	21 1/8	19	19	10 1/8	20 5/16	20 5/16	10 11/16	<b>DUAL SIDE BY SIDE FIRE DEPARTMENT VALVE &amp; EXTINGUISHER OR 2 FIRE DEPARTMENT VALVES:</b> 1-1/2" or 2-1/2" Fire Department Valve with Cap and Chain Plus Extinguisher - Cosmic & Galaxy 2 1/2 - 10, Mercury 2 1/2 - 11, Grenadier, Saturn 15-25, Sentinel 5
8415	8425	8435	Flat Trim	18	18	10	21 3/8	21 3/8	19	19	9 7/8	20 5/16	20 5/16	10 15/16	
8416	8426	8436	1 1/4" Square	18	18	10	21 3/8	21 3/8	19	19	8 7/8	20 5/16	20 5/16	9 15/16	
8417	8427	8437	2 1/2" Rolled	18	18	10	21 3/8	21 3/8	19	19	7 5/8*	20 5/16	20 5/16	8 11/16*	
8413	8423	8439	Surf. Mtd.	21 3/16	21 3/16	10 1/2	21 3/8	21 3/8	--	--	--	--	--	--	
8714	8724	8734	Trimless 5/8" Drywall ‡	26	26	8	29 1/8	29 1/8	27	27	8 1/8	28 5/16	28 5/16	8 11/16	<b>DUAL EXTINGUISHER CABINET WITH SHELF:</b> Extinguisher or Fire Dept. Valve - Shelf located 12" from bottom of cabinet - Any Extinguisher Except Sentinel 15-20, 272
8715	8725	8735	Flat Trim	26	26	8	29 3/8	29 3/8	27	27	7 7/8	28 5/16	28 5/16	8 15/16	
8716	8726	8736	1 1/4" Square	26	26	8	29 3/8	29 3/8	27	27	6 7/8	28 5/16	28 5/16	7 15/16	
8717	8727	8737	2 1/2" Rolled	26	26	8	29 3/8	29 3/8	27	27	5 5/8*	28 5/16	28 5/16	6 11/16*	
8713	8723	8739	Surf. Mtd.	29 3/16	29 3/16	8 1/2	29 3/8	29 3/8	--	--	--	--	--	--	
8614	8624	8634	Trimless 5/8" Drywall ‡	26	26	10	29 1/8	29 1/8	27	27	10 1/8	28 5/16	28 5/16	10 11/16	
8615	8625	8635	Flat Trim	26	26	10	29 3/8	29 3/8	27	27	9 7/8	28 5/16	28 5/16	10 15/16	
8616	8626	8636	1 1/4" Square	26	26	10	29 3/8	29 3/8	27	27	8 7/8	28 5/16	28 5/16	9 15/16	
8617	8627	8637	2 1/2" Rolled	26	26	10	29 3/8	29 3/8	27	27	7 5/8*	28 5/16	28 5/16	8 11/16*	
8613	8623	8639	Surf. Mtd.	29 3/16	29 3/16	10 1/2	29 3/8	29 3/8	--	--	--	--	--	--	
8014	8024	8034	Trimless 5/8" Drywall ‡	16	40	9	19 1/8	43 1/8	17	41	9 1/8	18 5/16	42 5/16	9 11/16	
8015	8025	8035	Flat Trim	16	40	9	19 3/8	43 3/8	17	41	8 7/8	18 5/16	42 5/16	9 15/16	
8016	8026	8036	1 1/4" Square	16	40	9	19 3/8	43 3/8	17	41	8 1/8	18 5/16	42 5/16	8 15/16	
8017	8027	8037	2 1/2" Rolled	16	40	9	19 3/8	43 3/8	17	41	6 5/8*	18 5/16	42 5/16	7 11/16*	
8013	8023	8039	Surf. Mtd.	19 3/16	43 3/16	9 1/2	19 3/8	43 3/8	--	--	--	--	--	--	

Dimensions in Inches

FOR KNOCKOUT LOCATIONS, SEE SUBMITTAL. \* ADD 5/8" FOR CABINETS WITH ALUMINUM FRAMES, \*\* KNOCKOUTS NOT AVAILABLE ON STAINLESS TUBS OR FIRE-RATED FX2 CABINETS, ‡ TRIMLESS MODELS FEATURE NEW DESIGN AND MAY BE INSTALLED BEFORE DRYWALL - SEE SUBMITTAL AND INSTALLATION INFORMATION



# FIRE BLANKETS & ACCESSORIES

## LOCKS & LOCK BOXES



## ALARMS

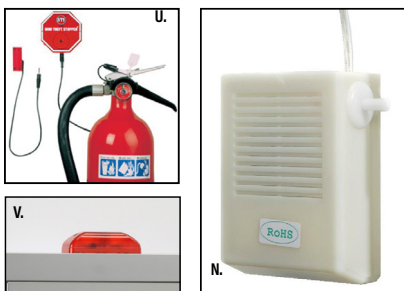

**N. COMMANDER ALARM**  
EASY TO INSTALL CABINET ALARMS PROTECT AGAINST THEFT OR TAMPERING. THE COMMANDER ALARM (SHOWN HERE) IS AN ECONOMICAL CHOICE.

## PULLS

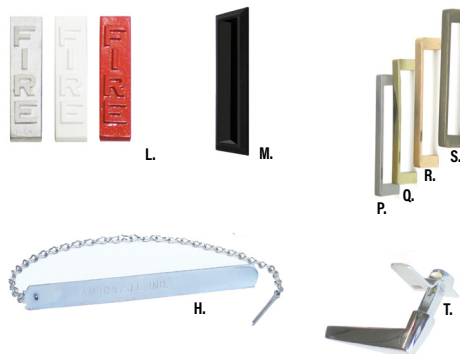

## ACCESSORIES

- A Security lock box 4" x 6" x 2 1/2" #LB
- B Security lock box alarm cover 6" x 6" x 2 1/2" #LBAC
- C Fire Dept lockbox L.A.F.D. with red decal, 16 gauge, 5" x 5" x 1 1/2" approved lockbox for L.A. county #LBA16
- D Keyed-alike Abus padlock #PL
- E Samson brass keyed-alike padlock #PLB
- F Break glass lock lever assembly LL24-KIT
- G Fire department lock box 4" x 6" x 1 1/2" #LBFD
- H Breaker bar with chain #HCM
- L Futura "FIRE" handle #PUF, PUF, PUF
- M Flush pull handle
- N Commander Alarm
- O Standard zinc pull #PUS
- P Chrome pull #PUCH
- Q US10B pull
- R Bronze pull
- S Brass pull
- T Lever Handle #LH
- U Brigadier alarm (BA)
- V Strobe alarm (SA)

## FIRE BLANKETS AND CABINETS

**Fire Blankets & Cabinet:** Royal fire blanket cabinets come in two basic designs. The Royal 9519S21 is a roller type for emergency use. The enclosed blanket is attached to the vertical roller and comes with arm loops to enable a person to wrap themselves in the blanket in one continuous motion. The Royal 9613S21 is a handy "drop" type with folded blanket. Both units are surface mounted. Each comes with a nominal 62" x 80", 2.75 pound, processed wool/synthetic fire blanket, which meets the Flammable Fabrics Act: Flammability of Clothing Textiles, Title 16, CFR1610.



## BLANKET & EXTINGUISHER COMBINATION CABINET

**Door & Trim Construction:** CRS with white powder-coat finish, clear anodized aluminum or #4 stainless steel. Flush cabinet doors with a 5/8" door stop are attached by a continuous hinge and equipped with zinc-plated handle and roller catch.

**Trim Style & Depth:** Recessed - 3/8" flat trim, Semi-recessed - 1-1/2" square trim, 2-1/2", 4" or 4-1/2" rolled edge, Surface-Mounted - square edge. Rolled edge aluminum trims formed of extrusions. 1-3/4" face trim on frame and 1-1/4" trim on door.

**Tub:** CRS with white powder coat finish standard. Tub of surface mounted models are same material as trim.

**Door Style:** Full Glass, Vertical Duo, Solid Door.

**Glazing:** .09 Acrylic, tempered or WireShield™ filmed wire glass.

**Shelf:** Shelf is located 9" from the top of the cabinet, providing storage of the blanket above the extinguisher.

**Blanket:** Each cabinet includes a nominal 62" x 80" x 2.75 lb, processed Wool/synthetic fire blanket.

**Fire Rated Option Available:** Yes

**Options at Additional Cost:**

SAF-T-LOK™

Flush Pull

Futura "Fire" Handle in Red, White or Mill

Lettering in Black or Red Pg. 21

Optional Color Trim & Door or Tub -

Color Anodizing for Aluminum Finishes Pg. 24

Wall Signs, Labels & Alarms pg. 20-21



3616F10

TRIM & DOOR & SERIES #			TUB I.D.	FRAME O.D.			Wall Opening: Non-Rated			Wall Opening Fire-Rated			ACCOMMODATES FOLLOWING EXTINGUISHERS		
Steel	Aluminum	Stainless	Trim Style	W	H	D	W	H	D	W	H	D			
3615	3625	3635	Flat Trim	12	36	8	15-3/8	39-3/8	13	37	8	14 5/16	38 5/16	8 15/16	Cosmic & Galaxy 2.5-10, Mercury 2.5-15 (FM1C & 15C), Sentinel 5, Grenadier
3616	3626	3636	1-1/2" Square	12	36	8	15-3/8	39-3/8	13	37	6-3/4	14 5/16	38 5/16	7 11/16	
3617	3627*	3637	2-1/2" Rolled	12	36	8	15-3/8	39-3/8	13	37	5-3/4*	14 5/16	38 5/16	6 11/16*	
3612	3622*	3632	4" Rolled, Flush Pull	12	36	8	15-3/8	39-3/8	13	37	4-1/4*	14 5/16	38 5/16	5 3/16*	
3618	3628*	3638	4-1/2" Rolled	12	36	8	15-3/8	39-3/8	13	37	3-3/4*	14 5/16	38 5/16	4 11/16*	
3613	3623	3633	Surface-Mtd.	15-3/16	39-3/16	8	15-3/8	39-3/8	---	---	---	---	---	---	

\*ADD 5/8 TO DEPTH NEEDED FOR THIS CABINET IN ALUMINUM.



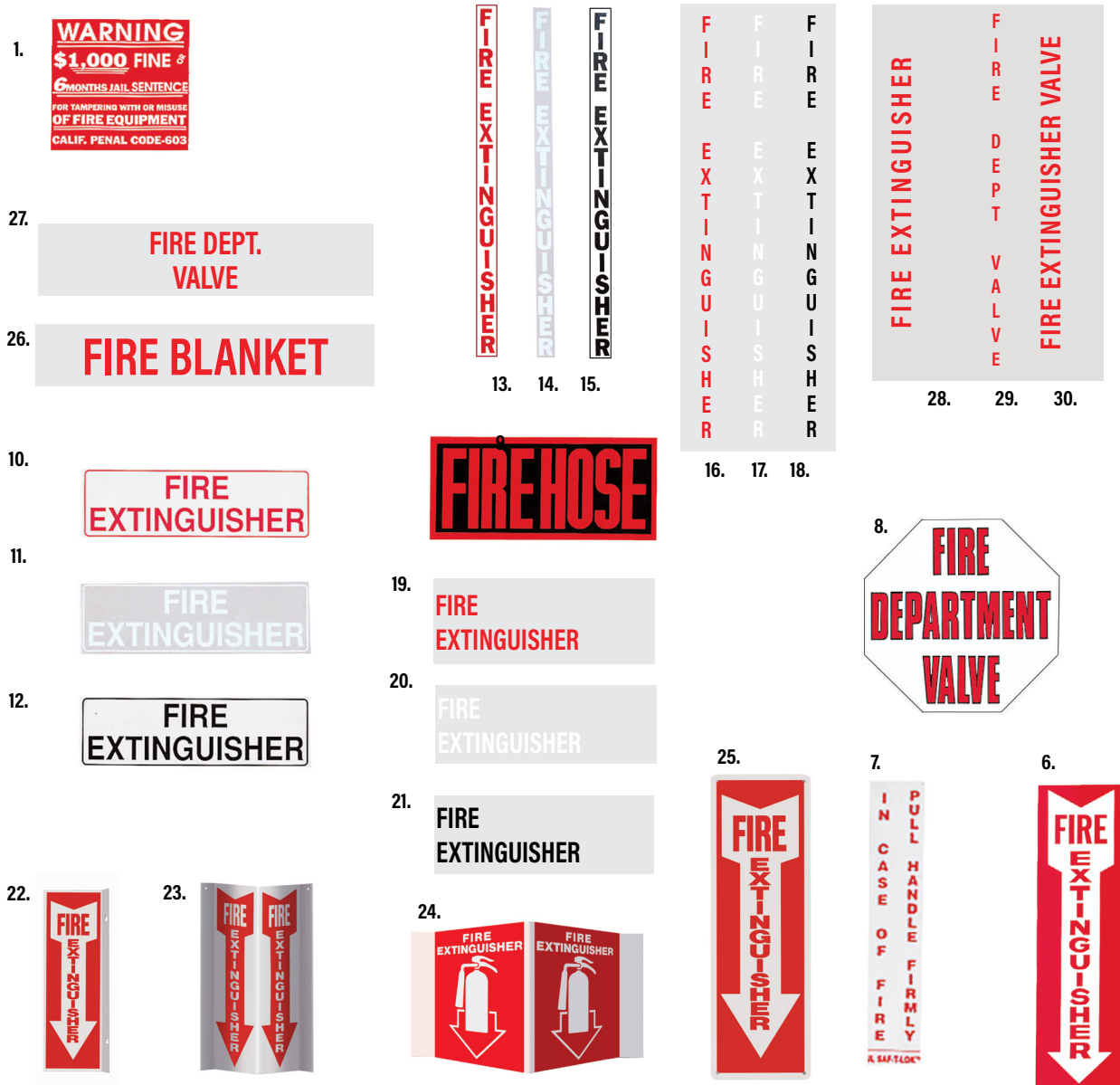

## DECALS AND DIE CUT LETTERING

DECALS & DIE CUTS	
1	Decal: 4" x 4" - red & white, WARNING #DRWF
6	Decal: 12" x 3 1/2" - vertical, red & white, FIRE EXT. #DRFA
7	Decal: 1" x 4 1/4" - vertical, red & white, IN CASE OF FIRE #PHCD-RED
8	Decal: 6" x 6" - octagonal, red, black & white, F.D. VALVE #FDVO
9	Decal: 4" x 9" - horizontal, black & red, FIRE HOSE #1403
10	Decal: 7 1/8" x 2 1/4" - horizontal, red & white, FIRE EXT. #LDHRFE
11	Decal: 7 1/8" x 2 1/4" - horizontal, FIRE EXT. #LDHWFE
12	Decal: 7 1/8" x 2 1/4" - horizontal, black & white, FIRE EXT. #LDHBF
13	Decal: 2" x 19" - vertical, red/clear FIRE EXT. #LDVRF
14	Decal: 2" x 19" - vertical white/clear FIRE EXT. #LDVWF
15	Decal: 2" x 19" - vertical black/clear FIRE EXT. #LDVBF
16	Diecut: 3/4" x 18" - vertical, red, FIRE EXT #LDCVRF
16R	Diecut: 3/4" x 18" - vertical, red, in reverse FIRE EXT #LDCVRRF
17	Diecut: 3/4" x 18" - vertical, white, FIRE EXT#LDCVWF
17R	Diecut: 3/4" x 18" - vertical, white, FIRE EXT in reverse #LDCVWRF

DIECUT LETTERING & SIGNS	
18	Diecut: 3/4" x 18" - vertical, black, FIRE EXT #LDCVBF
18R	Diecut: 3/4" x 18" - vertical, black, in reverse FIRE EXT#LDCVBRF
19	Diecut: 2 1/4" x 7 3/4" - horizontal, red, FIRE EXT#LDCHRF
20	Diecut: 2 1/4" x 7 3/4" - horizontal, white, FIRE EXT#LDCHWF
21	Diecut: 2 1/4" x 7 3/4" - horizontal, black, FIRE EXT#LDCHBF
22	Plastic sign: 4" x 12" 3D angle FIRE EXTINGUISHER #22S
23	Plastic sign: 4" x 18" 3D tent FIRE EXTINGUISHER #23S
24	Plastic sign: 5" x 6" 3D tent FIRE EXTINGUISHER #24S
25	Plastic sign: 4" x 12" flush vertical FIRE EXT #25S
26	Diecut: 7 7/8" x 1" - horizontal, red, FIRE BLANKET #LDCHRFB
27	Diecut: 10 1/4" x 4 3/8" - horizontal, red FD VALVE #LDCHRFDV-R
28	Diecut: 3/4" x 18" - ascending, red, FIRE EXT #LDCVARF
28R	Diecut: 3/4" x 18" - ascending, red, reverse FIRE EXT #LDCVARRF
29	Diecut: 3/4" x 17" - vertical, red FIRE DEPT VALVE #LDCVRFV
30	Diecut 1" x 17" - ascending red FIRE DEPARTMENT VALVE # LDCARFDV



# PROJECT SHOWCASE

- 1144 Fifteenth - Denver, CO
- 3M Headquarters - Maplewood, MN
- Apple Park (Apple's "Spaceship" campus) - Cupertino, CA
- Archer Hotel - Napa CA
- Bronx Mental Health Adult Behavioral Health Center - New York, NY
- Centurylink Arena - Omaha, NE
- Cherry Hospital - Goldsboro, NC
- Choctaw Casino Resort - Durant, OK
- Cyrus One Data Center - Houston TX
- Cyrus One Data Center - Sterling VA
- Department of Defense
- Disney Coronado Springs - Orlando FL
- Exxon Mobil Campus - Houston, TX
- Fort Bliss Hospital - El Paso, TX
- Hard Rock Stadium - Miami Gardens, FL
- Indianapolis International Airport - Indianapolis, IN
- Kimpton Argyle Hotel - Hollywood, CA
- Lambeau Field Renovations - Green Bay, WI
- Levi's Stadium - Santa Clara, CA
- Microsoft Data Center - Des Moines, IA
- NYU College of Nursing/Dental - New York, NY
- Radisson Blu Mall of America - Bloomington, MN
- Ritz Carlton Residence Towers - Waikiki Beach HI
- SalesForce Tower - San Francisco, CA

- Sanford Health Facilities - Fargo ND, Sioux Falls, SD
- Sentry Insurance Headquarters Expansion - Stevens Point, WI
- Target Field - Minneapolis, MN
- Toyota - Plano, TX
- United Health Group Corporate Campus - Eden Prairie, MN
- Universal Studios Aventura Hotel - Orlando FL
- University of Kentucky Flats Dorms - Lexington, KY
- U.P. Health System - Marquette, MI
- US Bank Stadium - Minneapolis, MN
- Wilshire Grant Tower - Los Angeles, CA
- World Trade Center VSC Project - New York NY



**HAZELTINE NATIONAL CLUBHOUSE  
CAVALIER SERIES**



**TARGET FIELD - COSMOPOLITAN SERIES**



**RADISSON BLU - COSMOPOLITAN SERIES**



## KEY TO CABINET NUMBER SYSTEM

Recessed Tub Size (I.D.)		Door/Trim Material		Trim Depth	
15	10 1/2 x 24 x 4	1	Steel, white primer finish	2	Semi-Recessed 4" rolled edge (Flush pull)
17	10-1/2 x 24 x 5	2	Aluminum, #180 clear satin anodized finish	3	Surface Mount (4", 6", 8" or 9"), square edge for steel and aluminum
18	10 1/2 x 24 x 5 1/2	3	Stainless Steel, #4 satin finish	4	Trimless recessed flange for 5/8" drywall or 3/4" plaster.
10 & 12	10 1/2 x 24 x 6	4	Bronze, US 10 satin clear coated finish	5	Full recessed 3/8", square edge
11	9 x 18 x 4 11/16	5	Brass, US 3 polished coated finish	6	Semi-recessed 1 1/4", 1 1/2", square edge
20	12 x 27 x 7 3/4	7	US4 Satin Brass (priced on application)	7	Semi-recessed 2 1/2" or 3" rolled edge
25	14 x 30 x 4	8	US10B Oil-rubbed Bronze (priced on application)	8	Semi-recessed 4 1/2", rolled edge
30	16 x 32 x 7 3/4	9	Color Anodizing on Aluminum (priced on application)	9	Surface mount 4", 6", 8" or 9" rolled edge for stainless steel or steel. (May be a special order item)
36	12 x 36 x 8	<b>Note:</b> Bronze and brass are not available in 40, 45, or 58 tub sizes. Special materials and finishes are available. Contact JL with your special requirements.		<b>Note:</b> Bronze and brass are not available in # 8, 9 or 2 trim depths.	
40	20 x 27 x 7 3/4	<p style="text-align: center;">TOP VIEW</p> <p>TRIMLESS RECESSED FLANGE FOR 5/8" DRYWALL OR 3/4" PLASTER    3/8" FLAT TRIM    1-1/2" SQUARE TRIM    2-1/2", 3" ROLLED EDGE    4" ROLLED EDGE WITH RECESSED PULL STANDARD    SURFACE MOUNT SQUARE TRIM    SURFACE MOUNT OPTIONAL ROLLED EDGE</p> <p><b>*Note:</b> For surface mount cabinets, add 3 3/16" to width and height measurements. See product page for wall opening dimensions.</p>			
45	28 x 30 x 4				
55	18x18x7-3/4				
56	10 1/2 x 24 x 5 3/4				
57	16 x 32 x 7 3/4				
58	32 x 32 x 7-3/4				
59	16 x 40 x 8-3/4				
60	24 x 30 x 6				
61	24 x 30 x 8				
62	24 x 34 3/4 x 6				
63	30 x 30 x 8				
64	24 x 34 3/4 x 8				
65	32 3/4 x 34 3/4 x 8				
66	24 x 38 3/4 x 8				
72	32 3/4 x 38 3/4 x 8				
80	16 x 40 x 9				
81	9 x 18 x 5 1/2				
84	18 x 18 x 10				
85	18 x 18 x 8				
86	26 x 26x10				
87	26 x 26 x 8				

Door Style		Door Glazing	
B10	Solid with acrylic insert and Saf-T-Lok™ with pull handle	10	Clear acrylic
D	Duo panel with pull handle	13	Clear wire w/ Safety Film
E	Duo panel with Saf-T-Lok™ with pull handle	15	1/4" bronze acrylic
F	Full glass with pull handle	16	1/4" gray acrylic
G	Full glass with Saf-T-Lok™ with pull handle	17	Clear tempered glass
L22	Solid with lock, no glazing and pull handle	18	Clear safety glass
S21	Solid with pull handle, no glazing (except Embassy)	25	Clear Bubble - Clear Vu, SMB, RBC
L24	Solid with cylinder lock & no pull handle	26	Red Bubble - Clear Vu, SMB, RBC
V	Vertical Duo Panel with pull handle (except Embassy)	27	Bronze Bubble - Clear Vu, SMB, RBC
W	Vertical Duo Panel with Saf-T-Lok™ with pull handle		
Panorama Door Styles Below		Panorama Glazing Styles Below	
P	Colored acrylic for Panorama, with pull handle	40	3/16" Black acrylic with white "V" letter
Q	Colored acrylic for Panorama, with Saf-T-Lok™	41	3/16" Red acrylic with white "V" letter
		42	3/16" White acrylic with black "V" letter
		43	3/16" White acrylic with red "V" letter
		45	3/16" Black acrylic with white "H" letter
		46	3/16" Red acrylic with white "H" letter
		47	3/16" White acrylic with black "H" letter
		48	3/16" White acrylic with red "H" letter
		50	3/16" Black acrylic with white "A" letter
		51	3/16" Red acrylic with white "A" letter
		52	3/16" White acrylic with black "A" letter
		53	3/16" White acrylic with red "A" letter
C	Clear acrylic for Panorama, frameless	70	Clear 3/16" acrylic with pull handle
		71	Clear 3/16" acrylic with Saf-T-Lok™

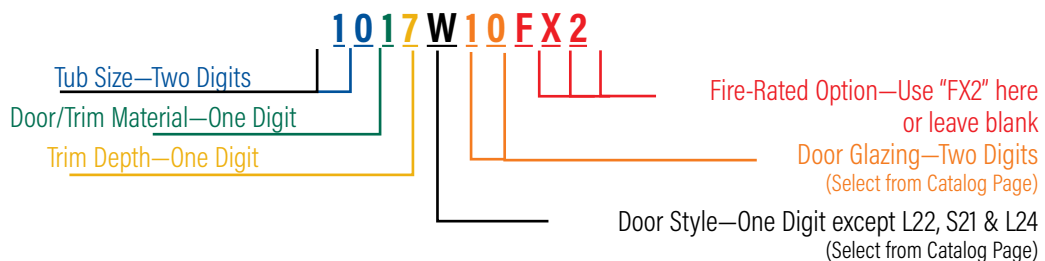



# OPTIONAL METAL FINISHES

## OPTIONAL POWDERCOAT PAINT COLORS



RED (R)



BLACK (B)



BRONZE (BR)



BRASS (BRA)



SAND (S)



SC BEIGE (SB)

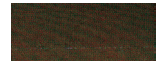

DARK ANODIZED



SILVER (SI)



GRAY HAMMERTONE (GH)

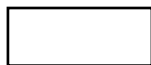

WHITE (W)



AMS BEIGE (AB)



ORANGE (O)











SAFETY YELLOW (Y)

PLEASE REFER TO PRODUCT PAGE TO SEE WHICH COLOR OPTIONS ARE AVAILABLE

## ANODIZED ALUMINUM

# OTHER PRODUCTS FROM JL INDUSTRIES

 <b>CORNER GUARDS</b>	 <b>LABORATORY FUME HOODS   CASEWORK</b>	 <b>FLOOR DOORS</b>	 <b>ACCESS PANELS</b>
 <b>AED'S</b>	 <b>AED CABINETS</b>	 <b>ROOF HATCHES</b>	 <b>SMOKE VENTS</b>
 <b>ENTRANCE MAT AND GRATING SYSTEMS</b>			

# ACTIVAR INC.

CONSTRUCTION PRODUCTS GROUP



JL INDUSTRIES



AIR LOUVERS



HIAWATHA



SAMSON



THOMAS



ROOFTOP

**CONTACT US:** PHONE: 800-554-6077 | FAX: 952-835-2218

**EMAIL:** SALES@ACTIVARCPG.COM

**MANUFACTURING:** BLOOMINGTON, MN | COMMERCE, CA

**WAREHOUSES:** DALLAS, TX | LANCASTER, PA | SEATTLE, WA | FARGO, ND | OMAHA, NE | FT MYERS, FL | ATLANTA, GA

The Activar Construction Products Group (ACPG) is a dynamic group of 6 companies that combine resources, innovation and experience to serve the commercial construction industry. For over 70 years, JL Industries, Samson Products, RoofTop Accessories and Thomas Enterprises have manufactured and distributed some of the leading lines of fire protection products including a full line of fire extinguishers and cabinets, AEDs and cabinets plus valve and hose cabinets. They also offer rated and non-rated access panels, roof accessories, corner guards, detention products and entrance floor mats & gratings. Air Louvers offers a wide variety of metal vision lites & louvers, specialized glass, astragals, and metal edging for both wood and hollow metal doors. Hiawatha Inc. has provided high-quality architectural door hardware and components for over 50 years. Our centrally-located warehouses and 2 manufacturing locations offer quick shipping of our most popular products to most major metropolitan areas of the US. The two manufacturing locations in California and Minnesota that offer a both a full range of products and custom manufacturing